

Roll-Over systems

The complete programme



The Real Car Wash Factory

Christ
WASH SYSTEMS



„Quality remains - long after
the price has been forgotten.“

Gottlieb Daimler, founder of the >>Daimler-Motoren-Gesellschaft DMG<<

We at the Otto Christ AG see ourselves as one of the leading, most innovative car wash manufacturers worldwide. Owned by the family Christ for over 138 years our company values our organic growth and the continuous improvement of our products. Our main focus is and has always been innovation. We perceive changes as chances and are proud to produce a high tech product that is nevertheless durable and of the highest quality. Our machines offer unique features for each segment of the market and we are proud to always strive to develop them further. Our customers, our distributors and our suppliers are an integrated part of our innovation process and enable us to meet the market demands of tomorrow.

We are looking forward to supporting you in your successful wash business and being a part of your success story.

Otto Christ
C.E.O.



Headquarters of the Otto Christ AG

Administration and production on over 35.333 m² roofed area



Production site in Pilzen (CZ) with over 29.082 m² roofed production space



OVERVIEW

- Our services for you
- Return on investment analysis
- What we see as „our standard“
- Many options, many uses
- Colours
- Our machine portfolio

ROLL-OVER SYSTEMS

- VARIUS
- GENIUS
- PRIMUS
- QUANTUS
- VARIUS 1+1
- VARIUS TAKT

ACCESSORIES & INNOVATIONS

4-5	• FOAM SPLASH	28-29
6-7	• Vitesse high pressure concept	30-31
8-9	• PROTECT SHINE Xpress	32-33
10-11	• Colour display system VISUS	34
12	• Effect lighting	35
13-15	• OPTIFLEX/Christ jointed brush	36-37
	• WHEEL MASTER	38-39
	• Wheel wash systems	40
	• Direct drive for brushes	41
	• MAXI FLEX+	42
	• Brush materials	43
16-17	• TURBO DRY	44-45
18-19	• Under chassis wash	46
20-21	• Rotating under-chassis wash unit	47
22-23	• User terminal VARIO	48-49
24-25	• Christ-Shop-Terminal	50-51
26-27	• Christ Information System (C-IS)	52-53
	• AIR-FIT/Technical container for roll-over wash units	54
	• Vacuum cleaner	55
	• Water recycling systems FONTIS/BIOCLEAR	56-57
	• All products at a glance	58-59

BP safety prize for contractors 2014



BP safety prize for contractors 2014

Top-Innovator 2009



Top-Innovator 2012



universal design award 2014



universal design award 2014

Total Safety Award 2014



Our successes

2009
2012
2014
2015

| Our services for you

Advice from professionals



Your local partner

- Fast advice on site
- Direct offers on site
- Personal consultation

Our concept

- Analyzing the local demand
- Calculating the return of investment
- Recommending the ideal solution

Our portfolio

- Roll-over systems
- Wash tunnels
- Self-service bays
- Train wash systems
- Water recycling
- CAR CARE products

Certificates

- DIN EN ISO 9001 (Quality management)
- DIN EN ISO 14001 (Environmental mgt.)
- OHSAS 18001 (Health and safety)
- SCC (Safety certificate contractor)

Tailored solutions

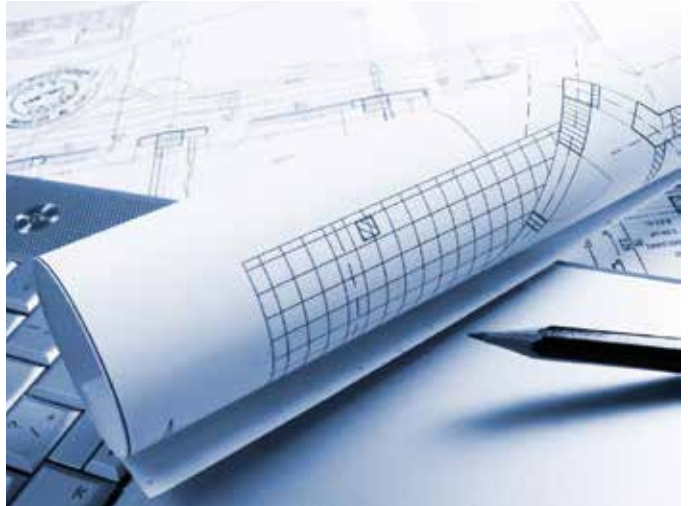

Planning and permits

- Direct support of local architects
- Supply of technical information needed for permits
- Detailed floorplans for local construction

Project management

- Support in project planning
- Meetings on the construction site
- Detailed information about necessary heavy machinery

Financing

- Our local partners are able to advise you about the available financing methods

With our flexible production we will
your machine

Analyzing local
demand and budget

Preparing offer and
getting approval for
financing if needed

Order and technical
review of site

Fast installations



Installation

- Installation by technicians certified by Christ
- Installation in accordance with local safety standards
- Commissioning and testing under supervision
- Instructions on use and maintenance

Chemicals

- Available directly from your local partner
- Christ chemicals are tailored to work perfectly with our machines
- www.christ-carwash-shop.com

Training

- Operator training will be done on site by certified technicians

First grade service



Service

- Area-wide aftersales service by our local distributor
- Direct access to your personal service technician
- Quick reaction times
- Hotline
- Fast supply of Christ spare parts
- Planned maintenance contracts
- Remote diagnosis via internet available

Marketing

- Marketing support with images and templates

Facelift

- Facelifts of existing systems are also available

Reporting

- Remote reports via internet
- Export and analyse all data

deliver and install
quickly and reliably!

Production of machine

Installation, commissioning and instruction

Return on investment analysis

Our local partner will be happy to supply you with a custom made business plan to find out your estimated return on investment. Please note that the calculation below is an example, all numbers are subject to change depending on local conditions.

Your benefit:

- Quick projection of sales figures and costs
- Can be done directly on site, no waiting
- Many locals costs are already included
- High investment security already in planning phase

Market analysis

Potential customers in catchment area	4.887
Sales potential p.a.	48.872
Sales potential p.m.	4.073
Estimated washes per year	9.774
estimated washes p.m.	815

Cost Analysis

Fixed costs per year

Electricity	990,00 €
Water	500,00 €
Maintenance	4.300,00 €
Insurance	1.000,00 €
Waste removal	2.500,00 €
Advertisements	2.500,00 €
other	0,00 €
Total costs p.a.	11.790,00 €

Variable costs*

Electricity	2.430,00 €
Water	2.860,09 €
Sewage	2.830,14 €
Chemicals	3.095,48 €
Maintenance	2.932,30 €
Total costs p.a.	p.a. 14.148,01 €

*depending on no. of washes

Investment costs

Purchase price	60.000,00 €
Equity	5.500,00 €
Total costs p.a.	8.623,86 €

Estate

Costs for estate p.a.	10.000,00 €
Other costs p.a.	- €
Initial construction	8.500,00 €

Total fixed costs

per year	30.413,86 €
per month	2.534,49 €
Initial investment in year 1	8.500,00 €

Price analysis

Program	1	2	3	4	5
Frequency	10%	20%	45%	15%	10%
Fixed costs / wash	0,31 €	0,62 €	1,40 €	0,47 €	0,31 €
Variable costs	0,05 €	0,96 €	1,29 €	1,49 €	1,49 €
Cost price	0,36 €	1,58 €	2,69 €	1,95 €	1,80 €
Price w. VAT	6,00 €	7,00 €	8,00 €	9,00 €	12,00 €
Price w/o VAT	5,04 €	5,88 €	6,72 €	7,56 €	10,08 €
Return	4,68 €	4,30 €	4,03 €	5,61 €	8,29 €

Program	6	7	8	9	10
Frequency	0%	0%	0%	0%	0%
Fixed costs / wash	- €	- €	- €	- €	- €
Variable costs	- €	- €	- €	- €	- €
Cost price	- €	- €	- €	- €	- €
Price w. VAT	10,00 €	11,00 €	12,00 €	13,00 €	14,00 €
Price w/o VAT	8,40 €	9,24 €	10,08 €	10,92 €	11,76 €
Return	8,40 €	9,24 €	10,08 €	10,92 €	11,76 €

Break Even Calculations

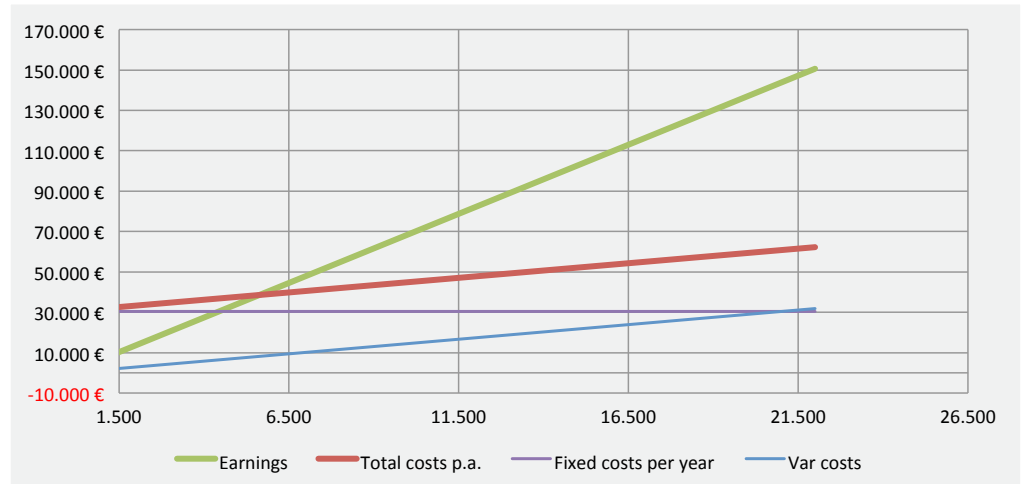

Break Even (washes per year)

5742,4224 p.a.

Break Even = all expenses (fixed costs + variable costs) are covered.

With a planned life span of 7 years, a total of 633 customers per month have to be served to cover all expenses and return the investment.

At a total number of 9774 washes per year, your yearly pre-tax profit will be

11.756,15 €

In the first year the initial construction in the amount of 8500€ has to be considered

Payoff after 3,32 years at 815 washes per month.

What we see as „our standard“

Included with each Christ machine without additional costs

Custom-made machines

Each Christ machine is made-to-order according to your request. This way you will always enjoy the newest technologies and will get a state of the art machine right out of the factory.

Individual colours

Choose your favorite colours for the brushes and plastic cladding of the machine from our selection of colours.

Basic chemical system

The right chemicals are the foundation of a great wash. This is why all of our machines come with two free dosing systems for shampoo and drying aid.

OPTIFLEX sidebrushes

Optimal contouring of the vehicle's sides with our pneumatically controlled side brushes.

User friendly

Easy access to the water system and the control cabinet

Hot-dip galvanised high quality steel frame

Each roll-over frame is first hot-dip galvanised and then powder-coated. This means an extraordinary resistance against corrosion and long machine life, even in the corrosive environment of a wash hall.

Duplex powder-coating

All our machines are duplex powder-coated for maximum resistance against corrosion.

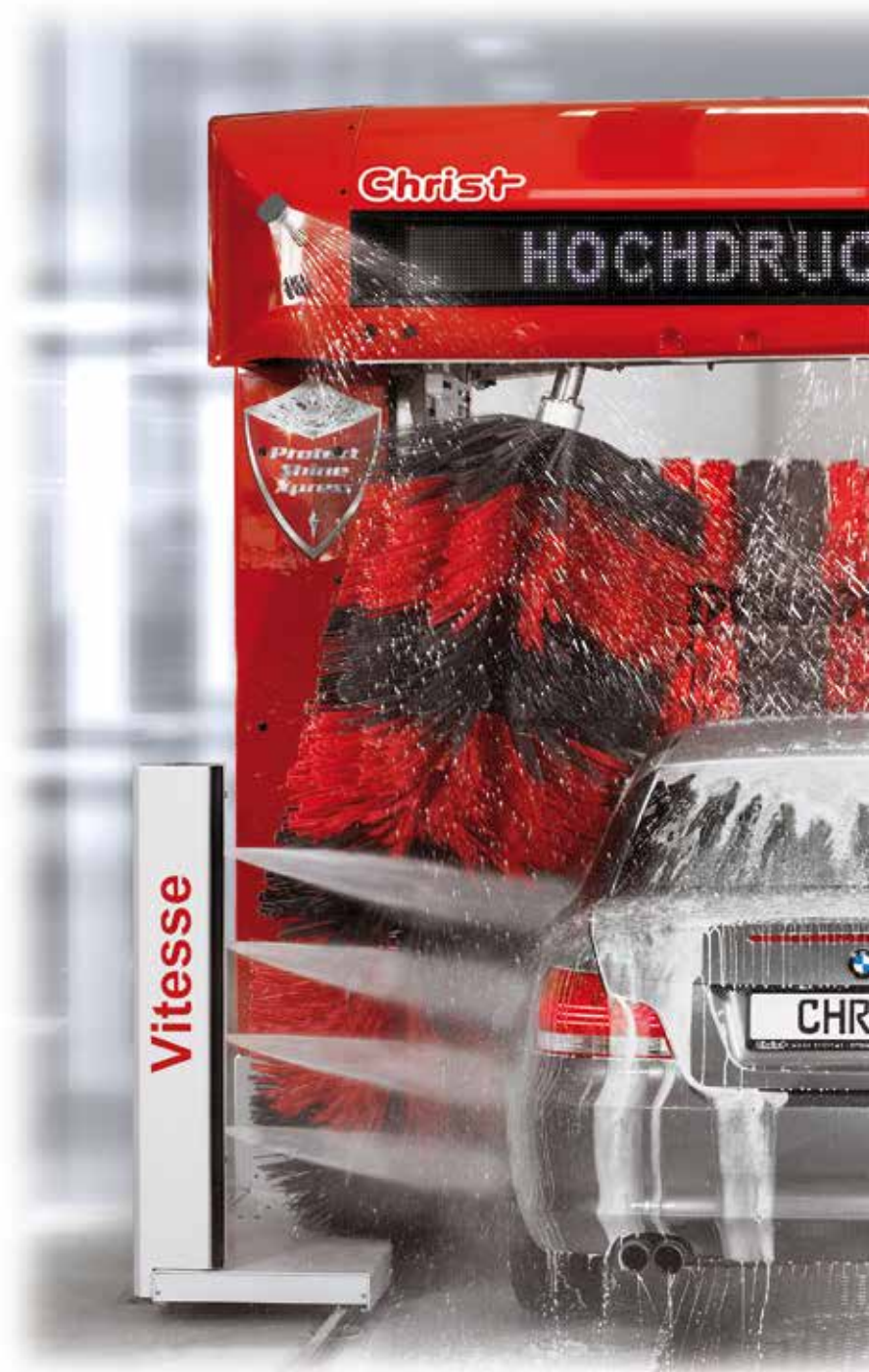



Dry-run protection system

Should the water supply fail at any time, the machine detects the dropping pressure and will stop immediately to avoid damaging the car.

Closed front and rear

All machines come with front and rear cladding in a colour of your choice from the Christ colour chart.

Anti-tilt system

Safety comes first! This is why all our machines are equipped with an anti-tilt system.

Brushes

PE brushes are always included, other premium brush materials are available on surcharge.

Self-testing machines

All Christ portals are equipped with a self-testing sequence. The machine checks the perfect function after the switch-on process.

Economical

Our system needs less water, electricity and chemicals due to the innovative design.

Many options, many benefits

A short description of the most important options



Active foam

The perfect start for a perfect wash: The car is being bathed in foamed soap. This tends to loosen crusted dirt on the vehicle and are especially effective on muddy or dusty vehicles. The foaming has two benefits: It gives a pleasant visual effect for the client and the chemical is less fluid and can stay longer in contact with the car's surface for higher efficiency.



High pressure pre-wash

After the active foam another cornerstone of a perfect wash: the high pressure pre-wash removes mud, sand and crusted dirt. This helps to avoid damages to the car's finish by sand particles caught in the brushes. Your clients will love the wow factor of the powerful water streaming over their vehicle and you can save time and costs in cutting back on manual pre-wash.



Wheel wash and high pressure wheel wash

Clean rims and tyres have become something that a client expects from any wash. Christ offers different solutions that are suited for your needs. The most popular option is a combined brush and high pressure system which we offer with different pressure and water volumes, but we also offer different types of brush only or high pressure only systems.



Under-chassis wash

A thorough under-chassis wash should be included in any premium offer. Christ does exclusively offer a rotating 85 bar under-chassis wash that effectively cleans the car from mud, salt or corrosive chemicals with minimal water consumption. Of course we also do offer the classic fixed or pivoting pipe system.

Jointed side brush

One of our trademark technologies: The patented Christ jointed brush has been developed by Christ and has proven its effectiveness over and over in the past decades. These jointed brushes also allow the successful use of textile washing materials over the entire side brushes and produces outstanding washing results.



Foam wax

A good finish for a good wash: similar to the active foam the foam wax stays longer on the vehicle's surface and creates an attractive gloss finish. In addition to the visual advantages foam wax is also very popular due to its conserving properties. Available for all Christ machines.



Special wax

For clients that want the perfect result: a special wax system can give a premium wash the ideal gloss finish and is very popular with premium clients. In comparison to foam wax, a purer chemical is applied. Special wax will also be polished into the car by the brushes. This option is available in several variations for all systems, from the classic category and upwards.



Drying

The end of every Christ wash: a thorough drying leaves a satisfied client and lets the car show off a clean and shiny surface. Specially shaped air channels and light barriers allow a very fast and efficient drying process. All Christ roof dryers are contouring dryers, machines of the premium category and above are able to rotate up to 140° to achieve the ideal angle for perfect drying.



Colours

Be creative!



All models available in individual, customized colours. The steel frame is always duplex powder coated in Telegrey (RAL 7047).

Name	Plastic cladding	PE BRUSH	SENSOTEX+	SENSOFIL+	SENSOMIX+	SENSODRY+
Ultramarine blue RAL 5002	✓	✓	✓	✓	✓	✓
sky blue RAL 5015	✓	✓	✓	✓	✓	✗
Flame red RAL 3000	✓	✓	✓	✓	✓	✓
Yellow green RAL 6018	✓	✓	✓	✓	✓	✗
Traffic green RAL 6024	✓	✓	✓	✓	✓	✓
Traffic yellow RAL 1023	✓	✓	✗	✓	✗	✗
Traffic orange RAL 2009	✓	✓	✗	✓	✗	✗
Pure white RAL 9010	✓	✓	✗	✗	✗	✗
Telegrey 4 RAL 7047	✓	✗	✗	✗	✗	✗
White aluminium RAL 9006	✓	✗	✗	✗	✗	✗
Grey aluminium RAL 9007	✓	✓	✓	✓	✓	✗
Jet black RAL 9005	✓	✓	✓	✓	✓	✓

The exact colours reproduced and pictures cannot be guaranteed. The indication of the colour shades RAL are merely an approximation and can vary according to application on different surfaces and materials.

Our machine portfolio

Roll-over systems



Our machine portfolio



All roll-over systems are built according to the standards of the German Association of the Automotive Industry



Model (Type)	VARIUS (C163)	GENIUS (C160)	PRIMUS (C169)
	Premium	Premium	Premium+
Category	Premium	Premium	Premium+
Typical operators	Petrol stations, car dealers / repair shops, fleet management	Petrol stations, car dealers / repair shops, fleet management	Petrol stations, car dealers / repair shops, fleet management
System type	Single gantry 3 brush machine with dryer	Single gantry 3 brush machine with dryer	Single gantry 3 brush machine with dryer
Washes per month	up to 1200	up to 1500	up to 1500
Brush material	PE, SENSOFIL+, SENSOMIX+, SENSOTEX+	PE, SENSOFIL+, SENSOMIX+, SENSOTEX+	PE, SENSOFIL+, SENSOMIX+, SENSOTEX+
Passage height (mm)	2300 - 3150	2300 - 3150	2100 - 2800
Passage width (mm)	2400/2550/2700	2400/2550/2700	2400
Track width (mm)	2500 - 3126	2500 - 3126	2500 - 3126
Pre-wash	AF, RC, SC, IR	AF, RC, SC, IR	AF, RC, SC, IR
Wash programs	customer-specific	customer-specific	customer-specific
Conservation	DA, FX, SWW, SWA, PSX	DA, FX, SWW, SWA, PSX	DA, FX, SWW, SWA, PSX
Drying height (mm)	1700/2000	1700	1570 - 2570
Special features	Roof dryer with self adjusting angle, large section for advertisement on front, visual layout possibilities	Roof dryer with self adjusting angle, Vitesse option	contouring side dryers, Add Dry, Vitesse option
Activation	Coins/chips, RFID cards, Pin code system, third-party solutions	Coins/chips, RFID cards, Pin code system, third-party solutions	Coins/chips, RFID cards, Pin code system, third-party solutions
Gearbox drive			
Direct drive	✓	✓	✓
Jointed brush	✓	✓	✓
Roof dryer	contour-following air valve with self adjusting angle	contour-following air valve with self adjusting angle	contour-following air valve with self adjusting angle
Side dryer	fixed	fixed	contouring / AddDry
Plastic covers	front & rear	front & rear	front & rear
Alarm for low chemicals	✓	✓	✓
Pictograms	✓		
LED front ticker		✓	✓
rear mounted LEDs	✓	✓	✓
RGB-wheel guiding tubes	✓	✓	✓

Legend:

AF = Active foam
RC = Rim cleaner
SC = Seasonal chemicals

IR = Insect remover
DA = Drying aid
FX = Foam wax

SWW = Special wax (water)
SWA = Special wax (air)
PSX = PROTECT SHINE Xpress



QUANTUS (C165)	VARIUS 1+1 (C162)	VARIUS TAKT (C161)
Petrol stations, car dealers/ repair shops, fleet management	Petrol stations, car dealers/ repair shops, fleet management	Petrol stations, car dealers/ repair shops, fleet management
Single 5 brush machine with dryer	Double gantry 1+1, 3 brushes and dryer	Double gantry Takt, 3 brushes and dryer
up to 2400	up to 2300	up to 4000
PE, SENSOFIL+, SENSOMIX+, SENSOTEX+	PE, SENSOFIL+, SENSOMIX+, SENSOTEX+	PE, SENSOFIL+, SENSOMIX+, SENSOTEX+
2250 - 2650	2300 - 2700	2300 - 2700
2400	2400	2400
2500 - 3126	2500 - 3126	2500 - 3126
AF, RC, SC	AF, RC, SC, IR	AF, RC, SC, IR
customer-specific	customer-specific	customer-specific
DA, FX, SWW, SWA	DA, FX, SWW, SWA, PSX	DA, FX, SWW, SWA, PSX
1700	1700/2000	1700/2000
high capacities in standard hall sizes, Vitesse option	Double gantry with separate washing and drying unit	Double gantry with separate washing and drying unit, textile brush dryer
Coins/chips, RFID Cards, PIN-Code-System, Third-Party solutions	Coins/chips, RFID cards, Pin code system, third-party solutions	Coins/chips, RFID cards, Pin code system, third-party solutions
✓	✓	✓
✓	✓	✓
contour-following air valve with self adjusting angle	contouring air valve with self adjusting angle	contour-following air valve with self adjusting angle
fixed	fixed	fixed
front & rear	front & rear	front & rear
✓	✓	✓
✓	✓	✓
✓	✓	✓
✓	✓	✓
✓	✓	✓

VARIUS

The individual car wash



Our all-rounder VARIUS is perfectly suited for a profitable wash business and will not disappoint with its high performance systems.

With the highly variable upgrades and accessories you can customize your VARIUS exactly to your specific needs. The attractive exterior design with its optional pictogram display will give your location an individual touch and is great for advertisement.

The highlight of this machine is the contouring and self-adjusting roof dryer that always uses the ideal drying angle. The system is electronically controlled and always monitored by light barriers to avoid any collisions between dryer and car.

The C163 VARIUS is targeted towards owners that are selling their washes like petrol stations, car dealers and repair shops.

Technical specifications

Ideal hall size (m)	10 x 5		
	passage width (mm) in mirror height		
Passage widths (mm)	2.400	2.550	2.700
2.300	•	•	•
2.400	•	•	•
2.500	•	•	•
2.600	•	•	•
2.700	•	•	•
2.800	•	•	•
2.900	•	•	•
3.150	•	•	•
Track width (mm)	2.400	2.550	2.700
2.500	•	-	-
2.700	•	•	-
2.800	•	•	•
2.900	•	•	•
3.126	•	•	•
Track width for wheel guiding tubes (mm)	2.400	2.550	2.700
2.050	•	-	-
2.100	-	•	•
Combined roof dryers	2 x 3,0 kW		
Combined side dryers	2 x 4,0 kW		

PREMIUM

Versatile



LED systems

The LED positioning system gives the driver exact and clear feedback about the correct position of the vehicle in the machine. In addition to the positioning system we also recommend the LED program pictograms that will give your clients feedback about the current progress of the wash program and the features that have been chosen.



Side dryers

An optimized side dryer with 1.700 mm drying height is already included in the basic model. You can upgrade to a 2.020 mm side dryer if a significant percentage of your customer base has SUVs or vans.



Contour-following roof dryer

In operation for over 15 years and optimized each year: Our contour-following and 140° rotating roof dryer can follow contours of SUVs, sports cars and anything in-between. Two drying fans with 3 kW each will effectively clear all vehicles of remaining water.



Wheel wash

Clean tyres and rims have become a must for a modern car wash. Christ offers a wide range of brush, HP+brush and touchless wheel washers and different types of chemical application for a perfect result.



Available technologies:

| Vitesse Option | **PROTECT SHINE Xpress** | **Program Display** | **VISUS DISPLAY** | **Jointed Brush** | **FOAM SPLASH**
| **MAXI FLEX+** | **WHEEL MASTER** | **TURBO DRY** | **Rim Spray Device** | **Insect Spray Device** | **Adjustable Side Blower**

GENIUS

The smart option



New and improved technologies in combination with proven and tested systems and a great design: Those things characterize our GENIUS.

Crafted with high quality materials, built in Germany and rigorously tested before shipment: This is a machine that will stay with you for a long time. The main difference to the VARIUS is the position of the brushes, the GENIUS has the side brushes at the front.

Diverse accessories and upgrades are available to adjust the machine to your needs, furthermore each machine will be shipped with exactly the programs you need without any additional cost.

The GENIUS is targeted towards repair shops and petrol stations with an intermediate number of wash clients. In combination with the Vitesse Option it is even suited for highly frequented locations.

Technical specifications

Ideal hall size (m)	10 x 5		
	passage width (mm) in mirror height		
Passage widths (mm)	2.400	2.550	2.700
2.300	•	•	•
2.400	•	•	•
2.500	•	•	•
2.600	•	•	•
2.700	•	•	•
2.800	•	•	•
2.900	•	•	•
3.150	•	•	•
Track width (mm)	2.400	2.550	2.700
2.500	•	-	-
2.700	•	•	-
2.800	•	•	•
2.900	•	•	•
3.126	•	•	•
Track width for wheel guiding tubes (mm)	2.400	2.550	2.700
2.050	•	-	-
2.100	-	•	•
Combined roof dryers	2 x 3,0 kW		
Combined side dryers	2 x 4,0 kW		

PREMIUM

Smart



Vitesse option

Exclusively available at Christ: This combination of active foam, oscillating high pressure and brush wash can save up to 20% time per wash. With one feature you can have up to 20% more turnover and your clients will enjoy the performance of the powerful jets. *More details on page 40*



Wheel wash

Clean tires and rims have become a must for a modern car wash. Christ offers a wide range of brush, HP+brush and touchless wheel washers and different types of chemical application for a perfect result.



LED systems

After the LED positioning system has guided the client safely into the machine, he can follow the progress of his wash on the large LED ticker on top of the machine. 6000 LEDs command attention, even if the machine is currently not active. Available also with a coloured, animated VISUS-Display.



Contour-following roof dryer

In operation for over 15 years and optimized each year: Out contour-following and 140° rotating roof dryer can follow contours of SUVs, sports cars and anything in-between. Two drying fans with 3 kW each will effectively clear all vehicles of remaining water.



Available technologies:

| Vitesse Option | PROTECT SHINE Xpress | Program Display | VISUS DISPLAY | Jointed Brush | FOAM SPLASH | MAXI FLEX+ | WHEEL MASTER | TURBO DRY | Rim Spray Device | Insect Spray Device | Adjustable Side Blower



If you were to ask which features are available for the PRIMUS the answer would be very simple: All of them!

As the flagship of the Christ product range the PRIMUS has a lot to offer: Besides standard features like cross over wash, computer controlled brush pressure and contour-following dryer the PRIMUS is equipped with the newest revolution in car wash system, the Direct Drive. This innovative motor system does not need any gearboxes and is able to change the speed of the brush at the blink of an eye. It is controlled by specially developed frequency converters and opens up a whole dimension of new wash programs. In addition to the Direct Drive the major strong suit of the PRIMUS is the unique drying concept with contour-following roof dryers, tilting side dryers and the AddDry option for high vehicles. These features will give you simply the best drying result that is currently available.

All brush materials are of course available, so you can equip your machine with PE, SENSOFIL+, SENSOTEX+ or SENSOMIX+. The PRIMUS is targeted towards operators with high end clientele or high end petrol stations.

Technical specifications			
Ideal hall size (m)	10 x 5		
	passage width (mm) in mirror height		
Passage widths (mm)	2.400	2.550	2.700
2.100	•	-	-
2.300	•	-	-
2.400	•	-	-
2.500	•	-	-
2.600	•	-	-
2.700	•	-	-
2.800	•	-	-
Track width (mm)	2.400	2.550	2.700
2.500	•	-	-
2.700	•	-	-
2.800	•	-	-
2.900	•	-	-
3.126	•	-	-
Track width for wheel guiding tubes (mm)	2.400	2.550	2.700
2.050	•	-	-
2.100	-	-	-
Combined roof dryers	2 x 3,0 kW		
Combined side dryers	2 x 3,0 kW		

PREMIUM+

Multifunctional



Unique drying system

The contour-following and rotating main dryer, the tilting side dryers and the optional van dryer AddDry all work together to achieve the perfect drying result. Since the AddDry upgrade reaches up to 2.5m, even high SUVs and transports will leave the machine spotless and dry.

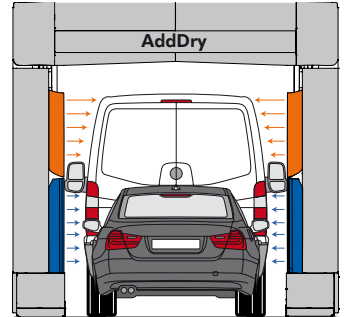

PROTECT SHINE Xpress

A new innovation made by Christ: With a special pattern of wax nozzles and temporarily higher rotation rate of the side brushes any program with wax is sped up considerably. You will be able to get up to 40% shorter wash times and still get the same, perfect result. *More details on page 42*



Vitesse-Option

Exclusively available at Christ: This combination of active foam, oscillating high pressure and brush wash can save up to 20% time per wash. With one feature you can have up to 20% more turnover and your clients will enjoy the performance of the powerful jets. *More details on page 40*



Direct drive

Another Christ-exclusive: The Direct Drive for roof and side brushes disposes of the old gear box based technology and uses frequency converters to control the brush speed. Beside energy savings of approx. 10% this means that if you switch wash materials you can simply adjust the machine with a software update, no work on the hardware necessary. *More details on page 51*



Available technologies:

| Vitesse Option | PROTECT SHINE Xpress | Program Display | VISUS DISPLAY | Jointed Brush | FOAM SPLASH | MAXI FLEX+ | WHEEL MASTER | TURBO DRY | Rim Spray Device | Insect Spray Device | Adjustable Side Blower

QUANTUS

Compact and powerful



The QUANTUS 5-brush machine is the work horse of the Christ machines. Developed for locations with high volumes but limited space it can reach a surprisingly high capacity while fitting in a 10m hall.

In combination with the Vitesse high pressure option a volume of 16 cars per hour can be reached with a normal wash program. The drying system has been upgraded to keep up with the high speed and has 1.6 kW more power than a standard Christ dryer. If this is still not fast enough, a special speed option is available that will HP prewash, brush-wash and dry a car in just two runs. Your local Christ partner will be happy to discuss the different options for programs with you, they are already included in the sales price of the machine.

The QUANTUS is targeted towards locations with a high volume and limited space and is the ideal upgrade if your current machine can't keep up with the demand.

Technical specifications

Ideal hall size (m)	10 x 5		
	passage width (mm) in mirror height		
Passage widths (mm)	2.400	2.550	2.700
2.250	•	-	-
2.350	•	-	-
2.450	•	-	-
2.550	•	-	-
2.650	•	-	-
Track width (mm)	2.400	2.550	2.700
2.500	•	-	-
2.700	•	-	-
2.800	•	-	-
2.900	•	-	-
3.126	•	-	-
Track width for wheel guiding tubes (mm)	2.400	2.550	2.700
2.050	•	-	-
2.100	-	-	-
Combined roof dryers	2 x 4,0 kW		
Combined side dryers	2 x 4,0 kW		

PREMIUM+

Industrious



Vitesse option

Exclusively available at Christ: This combination of active foam, oscillating high pressure and brush wash can save up to 20% time per wash. With one feature you can have up to 20% more turnover and your clients will enjoy the performance of the powerful 85 bar jets. *More details on page 40*



Contour-following roof dryer

In operation for over 15 years and optimized each year: Our contour-following and 140° rotating roof dryer can follow contours of SUVs, sports cars and anything in-between. Two drying fans with 4 kW each will effectively clear all vehicles of remaining water.



LED systems

After the LED positioning system has guided the client safely into the machine, he can follow the progress of his wash on the large LED ticker on top of the machine. 6000 LEDs command attention, even if the machine is currently not active. Available also with a coloured, animated VISUS Display.



The QUANTUS Express washing programme

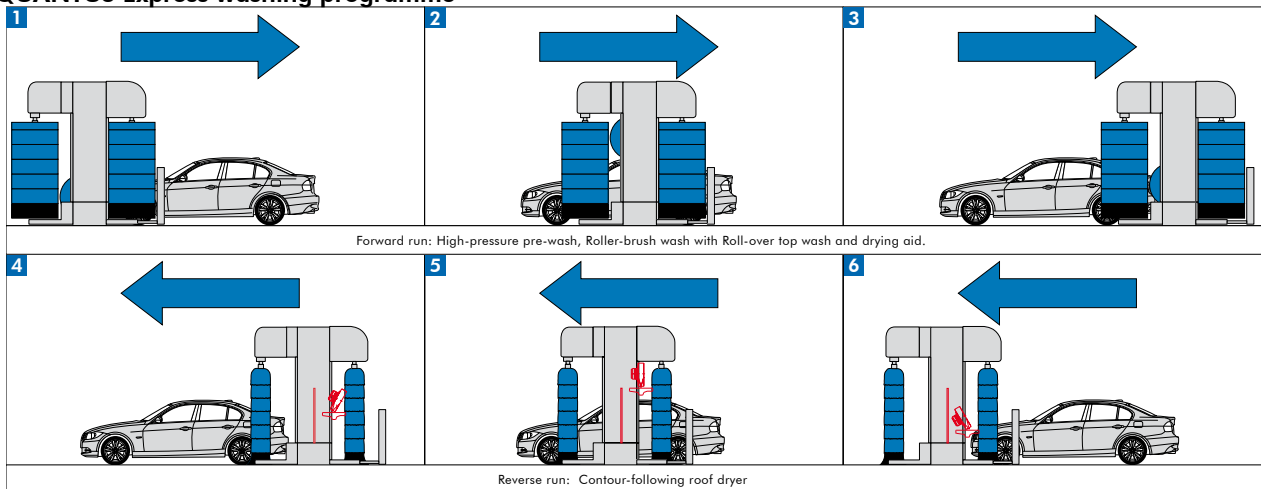

Available technologies:

| **Vitesse Option** | **PROTECT SHINE Xpress** | **Program Display** | **VISUS DISPLAY** | **Jointed Brush** | **FOAM SPLASH** | **MAXI FLEX+** | **WHEEL MASTER** | **TURBO DRY** | **Rim Spray Device** | **Insect Spray Device** | **Adjustable Side Blower**



The Christ VARIUS 1+1 is the team-player of the Christ machines. Two specialized portals, one for washing and one for drying are able to speed up the washing process considerably. On one run several functions can be executed at the same time, so e.g. active foam, brush wash, drying aid and drying can all be done in two runs. The high end dryer with 16 kW does only need one run and shortens the overall washing time as well.

One of the big advantages of the VARIUS 1+1 is its flexibility: With two separate portals even unusual programs are possible at high speeds. Your local Christ partner will be happy to advise you on the possibilities. A visual highlight is the possibility of using a 6000 LED ticker display and LED spots with pictograms at the same time.

The VARIUS 1+1 is targeted towards operators with high volumes.

Technical specifications			
Ideal hall size (m)	11 x 5		
	passage width (mm) in mirror height		
Passage widths (mm)	2.400	2.550	2.700
2.300	•	-	-
2.400	•	-	-
2.500	•	-	-
2.600	•	-	-
2.700	•	-	-
Track width (mm)	2.400	2.550	2.700
2.500	•	-	-
2.700	•	-	-
2.800	•	-	-
2.900	•	-	-
3.126	•	-	-
Track width for wheel guiding tubes (mm)	2.400	2.550	2.700
2.050	•	-	-
2.100	-	-	-
Combined roof dryers	2 x 4,0 kW		
Combined side dryers	2 x 4,0 kW		

Available technologies:

| Vitesse Option | PROTECT SHINE Xpress | Program Display | VISUS DISPLAY | Jointed Brush | FOAM SPLASH | MAXI FLEX+ | WHEEL MASTER | TURBO DRY | Rim Spray Device | Insect Spray Device | Adjustable Side Blower

PREMIUM+

Team-minded



Oscillating all-round high pressure

The all-round high pressure system comes with 12 point nozzles and 85 bar and is powerful enough to clean even the muddiest car. The back and forth movement of the 0° nozzles achieves a better result than the classical 15°/25° nozzles, and that at the same consumption rate.



Extra powerful rotating dryer

The rotating dryer adjusts automatically to the ideal angle and together with the high performance side dryers a total of 16 kW drying power is packed into the separate drying portal. Due to this high powered system, even 1.5 runs are enough to leave the car dry and ready to go.



Functional principle VARIUS 1+1



Car positioning in front of the drying portal. The wash portal is at the back at the starting position.

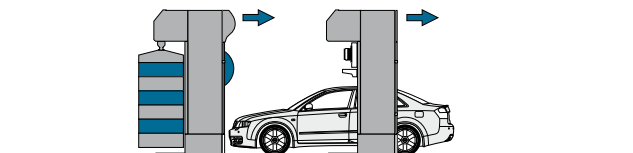

The drying portal moves from the waiting position to the entrance of the hall position. High pressure wash and foam wash will be carried out.

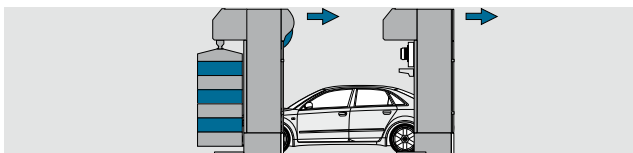

The following wash portal starts at the same time with the main wash.

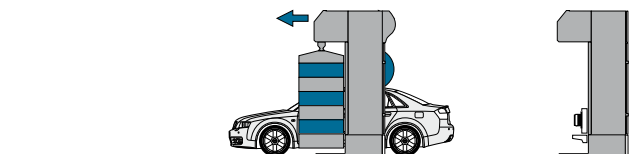

In the reverse run a drying aid will be used or a wash and wax agent will be applied.

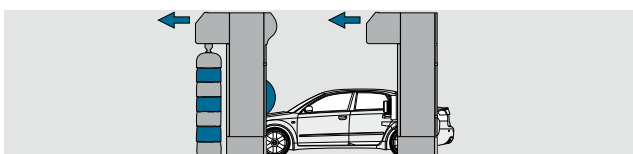

The following drying portal starts right at the end of the washing process. Time-saving car drying process is achieved with one run only.



A wash tunnel in roll-over size: That is the VARIUS TAKT. With its two separately placed portals it can give you up to double the capacity of a single portal unit.

The underlying principle of this machine is the division of labour: While drying portal is still drying a car the washing portal is already starting with the next client. When a car is washed the driver gets a signal to drive ahead into the drying area. This concept means, that the machine is nearly always working on two cars, effectively doubling its capacity. The peak capacity is at 20 cars per hour without any degradation of the wash quality.

In comparison to a full wash tunnel the price and the installation are the main arguments: While a tunnel requires heavy ground works for the conveyor you can simply install the VARIUS TAKT above ground in an existing hall.

A special option are the polishing brushes for the drying unit. Those brushes can be used after a special wax program to give the car a high quality gloss finish which does justify higher wash prices.

The VARIUS TAKT is targeted towards operators with a very high volume and demanding clients.

Technical specifications			
Ideal hall size (m)	20 x 5		
	passage width (mm) in mirror height		
Passage widths (mm)	2.400	2.550	2.700
2.300	•	-	-
2.400	•	-	-
2.500	•	-	-
2.600	•	-	-
2.700	•	-	-
Track width (mm)	2.400	2.550	2.700
2.500	•	-	-
2.700	•	-	-
2.800	•	-	-
2.900	•	-	-
3.126	•	-	-
Track width for wheel guiding tubes (mm)	2.400	2.550	2.700
2.050	•	-	-
2.100	-	-	-
Combined roof dryers	2 x 3,0 kW		
Combined side dryers	2 x 4,0 kW		

PREMIUM+

Fast



Double the speed

With two separately working portals VARIUS TAKT is the fastest roll-over system Christ has to offer. This machine won't let you down, even if the weather is good and the clients are lining up. Since washing and drying are in two separate areas it will seem even faster for your clients.



Easy maintenance

The chemicals and the control cabinet are, like with all Christ machines, easily accessible from the front. Due to the separation of drying and washing systems both portals are even easier to understand and maintain and all important modules can be reached directly.



SENSODRY+ polishing brushes

The optional polishing brushes of the drying unit take care of the finishing. The perceived quality of the wash is severely improved by this system and it is up to you if you want to offer special polishing programs or just use it with each wash as an advantage over your competition.

The drying material SENSODRY+ is very soft and is especially effective with Christ special wax.

Available technologies:

| Vitesse Option | PROTECT SHINE Xpress | Program Display | VISUS DISPLAY | Jointed Brush | FOAM SPLASH
| MAXI FLEX+ | WHEEL MASTER | TURBO DRY | Rim Spray Device | Insect Spray Device | Adjustable Side Blower

MAXIMUM ENTERTAINMENT,
OPTIMUM RESULTS



FOAM SPLASH

The XXL foam curtain

FOAM SPLASH is an optically spectacular concept for the active foam pre-wash process which has the optimum chemical impact on the vehicle.

The value to the customer and wash prices can be increased as a result. The foam is applied quickly across the entire width of the vehicle and is illuminated from the rear by an LED lighting console. A drip plate prevents dripping during the vehicle drying process.

The illuminated foam curtain is eye-catching and appeals to car wash customers from a distance.

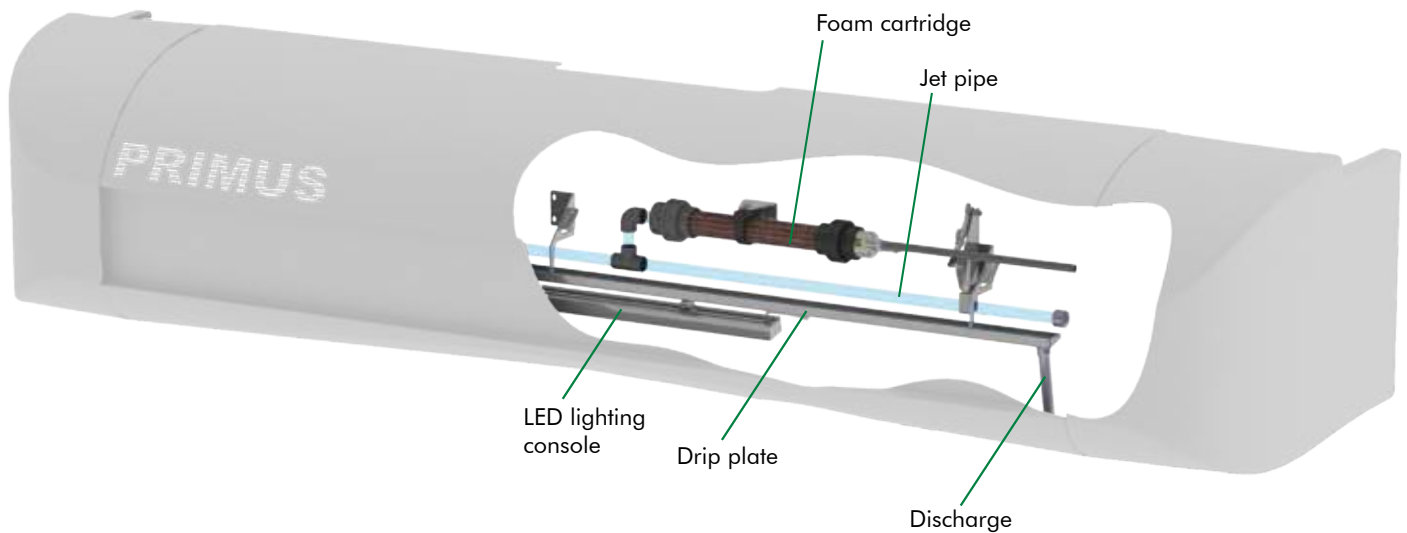

Your benefit:

- New wash experience for customers
- Foam application over the entire vehicle width
- Faster cycle without capacity loss
- No dripping during the drying process
- Insensitive to wind

Available for:

| VARIUS | GENIUS | PRIMUS | QUANTUS | VARIUS 1+1 | VARIUS TAKT

Vitesse high pressure concept

Save up to 20 % time



Time is scarce, especially in the wash business. At peak times clients don't want to wait too long for their wash and a high capacity machine can be a true competitive edge. Our solution for this challenge is the Vitesse Concept!

The Vitesse-concept is a unique combination of special functions which are installed on the front side of the unit. High pressure system with 8 oscillating nozzles per side which move at an angle of 25°, a distinct foam applicator with special Vitesse side nozzles and optimized internal processes. In conventional roll-over wash units the first foam run, the high-pressure pre-wash and the brush wash is done in 3 runs, but here all the functions are completed in

one single run. So the Vitesse-Concept saves 2 runs per wash and saves washing times per wash and therefore the unit's capacity is significantly increased!

This concept is only available with Christ machines and has been wildly successful since its launch in 2012. At costs of 2-5%* of the machine price the upgrade can give you up to 20% more capacity and will pay for itself within short order.

The high pressure bars each contain four 0° nozzles. Those oscillate 25°, driven by an encapsulated electric motor. The electric motor makes sure that 100% of the high pressure is used for cleaning the car and no energy is wasted creating the oscillation.

Comparison of wash program

Standard			washing time 7 min 34 s		
➔	➜	➔	➜	➔	➜
Active foam Rim chemicals	High pressure side wash	High pressure tyre wash Roller wash	Roller wash Under chassis wash Foam wax	Drying	Drying

Vitesse		washing time 6 min 02 s	
➔	➜	➔	➜
High pressure side washing Vitesse Fanning nozzles for foam washes Rim chemicals High pressure tyre wash Roller wash	Roller wash Tyres wash Under chassis wash Foam wax	Drying	Drying

Example calculation:

Based on an average of 800 washes per month. With a capital growth of 20%, this machine is capable of 160 additional washes per month, and with an average wash price of 8.20 € inclusive of VAT. This means more profit.

More profit:
 Capital growth 160 washes per month x
 8.20 Euros Average wash price
 = 1,312.00 per month
 1,312 x 12 months x 7 operational years
 = 110,208 € in 7 years

+20%
capacity

5%
price

Your benefit:

- Saves 2 runs per wash
- Saves more than 1:30 min per wash
- 20% more capacity
- Up to 2 washes more per hour

Available for:

| VARIUS | GENIUS | PRIMUS | QUANTUS | VARIUS 1+1 | VARIUS TAKT

PROTECT SHINE Xpress

A very clever overall concept!



PROTECT SHINE Xpress is an overall concept for a special wax programme of the next generation with 3 components: in addition to the special wax application with its own programme sequence, PROTECT SHINE Xpress includes the specially developed special wax from Christ CAR CARE and a wide range of marketing tools for the plant operator. Altogether PROTECT SHINE Xpress is an impressive premium offer for your customers!

The special wax with repair effect

PROTECT SHINE is a premium special wax from Christ CAR CARE. The combination of long-term conservation, repair effect and a special shiny gloss for the paintwork makes this product an absolutely unique selling proposition on the market. The ef-

fectiveness of PROTECT SHINE is increased by each further application. From continual use the car wash customer will notice the benefits and therefore be willed to pay for this, which in turn will result in an increase in revenue for the wash operator.



1 A new car has a smooth surface. The light is reflected evenly.

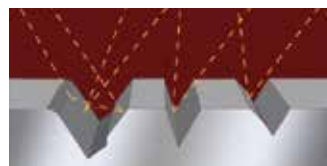

2 The surface is damaged and scratched with time, the gloss decreases.



3 PROTECT SHINE is applied after the wash and attaches itself to the car's surface.

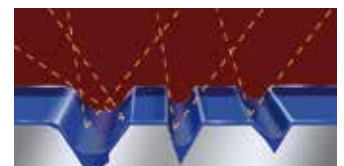

4 If applied regularly, a protective layer is created. Small scratches are being filled.



5 The finish is smooth and glossy once again.

The perfect add-on to the Vitesse option: PROTECT SHINE Xpress equipment



The special wax from Christ CAR CARE and the PROTECT SHINE Xpress equipment for Christ wash systems are perfectly synchronised to ensure the optimal wax application and the best possible conservation quality. The highest efficiency is achieved with the combination of the PROTECT SHINE Xpress equipment and the Vitesse option.

PROTECT SHINE is applied by its own fan nozzle heads that allow a large-volume foamed wax application. The washing customer benefits from this exclusive long-term conservation in the washing process and with increased use, the quality becomes better. This in turn, again, results in higher wash prices being able to be charged.

In combination with the Vitesse-concept and the Christ-exclusive direct drive, the unique Xpress programme sequence is possible: unlike other similar products from other vendors PROTECT SHINE Wax doesn't need to be dried half way through or washed off at the end. A high-pressure washing with PROTECT SHINE conservation is possible with its own programme sequence in only about 6 minutes, which corresponds to a capacity increase of approximately 40% compared to systems from its competitors. The full plant capacity therefore can be maintained, with the long-term conservation product, because the high turnover PROTECT SHINE premium offer can be actively sold in busy times by the plant operator, without long waiting times for the customers.

Effective marketing with Christ advertising materials

In systems with PROTECT SHINE Xpress features, an extensive advertising package is part of the deal. This includes large banners, posters and flyers for PROTECT SHINE. The operator can thus easily and effectively promote its new offer to attract the customer's attention and increase sales significantly.



Available for:

| VARIUS | GENIUS | PRIMUS | QUANTUS | VARIUS 1+1 | VARIUS TAKT

Colour display system VISUS

The VISUS colour display system gives the car wash unit a modern, contemporary look. This central communication unit for wash customers can be seen visibly from a distance. Only the respective, current, important information is displayed and, unlike other systems, no information overlapping takes place. Thus,

the VISUS colour display system also contributes to operational safety. When not in use it is used as a promotional tool by its animated gimmicks which can be seen from a distance and which draws the attention of passing potential customers.

RGB ticker VISUS



The VISUS colour moving screen for car wash units with front sided lateral brushes is integrated in the portal cross beam. Gimmicks and wash programme steps are fully animated and feature, in addition to the text information, the matching motion graphics.

Available for:

| VARIUS | GENIUS | PRIMUS | QUANTUS | VARIUS 1+1 | VARIUS TAKT

Door display VISUS

For portal systems with rear side lateral brushes the VISUS system consists of two colour displays in the side beams. In this system, the safety display warnings, the maximum passage height/width and the washing programme steps, are all combined by means of a large animated traffic-light display function. After the washing process, the customer will be rewarded with a smiley.



www.christ-ag.com/cms/presse/multimedia/portalwaschanlagen

Available for:

| VARIUS | GENIUS | PRIMUS | QUANTUS | VARIUS 1+1 | VARIUS TAKT

Effect lighting

RGB wheel guiding tubes

The landing strip for your customer!

The premium wheel guiding tubes of Christ are highly visible and colour-illuminated with LED technology. Individually controlled moving light functions, animated gimmicky break-fillers and the corresponding washing programme progress lighting effects, all draw the attention of the wash customer. They are thus an attractive advertising tool that clearly distinguishes the washing unit from the competition.

These illuminated wheel guiding tubes also give a guidance function that accurately directs the motorists into the car wash unit and keeps him in a straight position. Of course they also complement the traffic light function of the washing unit.



Available for:

| VARIUS | GENIUS | PRIMUS | QUANTUS | VARIUS 1+1 | VARIUS TAKT

RGB effect lighting

The lighting show is in the car wash unit!

A wrap-around coloured LED illuminated strip draws even more attention to the car wash unit. Through different lighting effects (for example, pulsating strobe) the car wash unit comes alive - the modern presentation is especially appealing to young wash customers. The individual programme steps are clearly distinguished with different signal colours. The enlargement of the traffic light function, the effect lighting also serves for operational safety. It is the perfect complement for the RGB wheel guiding tubes because the lighting effects are controlled in parallel.



Available for:

| VARIUS | GENIUS | PRIMUS | QUANTUS | VARIUS 1+1 | VARIUS TAKT

OPTIFLEX

Good side-cleaning performance as a standard feature



OPTIFLEX is the proven standard technology for the lateral brush wash with roll-over wash units. The fixed-side brushes are especially designed for wear and durability and therefore are the first choice for the lower cost washing operations. The precise cont-

rol of the contact pressure ensures safe operation and excludes damage to the vehicle. However, 2 overruns are necessary for a complete side wash because the rigid side brushes can only cover the car contour in parts, in each cycle.



These areas are being washed:

- Roof rails
- Side
- Sill area



- Roof rails
- Side
- Sill area



Average performance, high pressure, high immersion depth

Available for:

| VARIUS | GENIUS | PRIMUS | QUANTUS | VARIUS 1+1 | VARIUS TAKT

Christ jointed brush

The premium wash with maximum contour coverage



Proven over the years and a patented Christ technology, our jointed brush guarantees a perfect lateral wash. The jointed brush is always securely locked, excluding any oscillation of the side brush. The even contact pressure over the entire height guarantees an efficient and a smooth and gentle wash.

The complete vehicle contour is being covered at each overrun, so the cleaning performance can be 'doubled' compared to conventional systems. When washing vertical body sides (e.g. vans) the side brushes are locked vertically. Apart from the technical advantages, the angled brushes are perceived as 'high quality' and a special feature by your customers.

Forward run

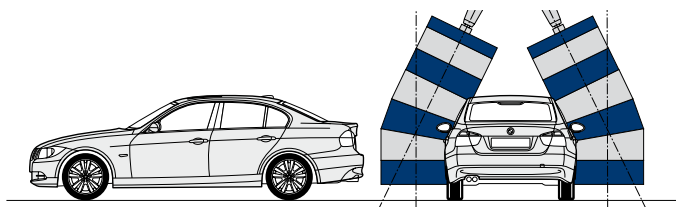

These areas are being washed:

- Roof rails
- Side
- Sill area



Backward run

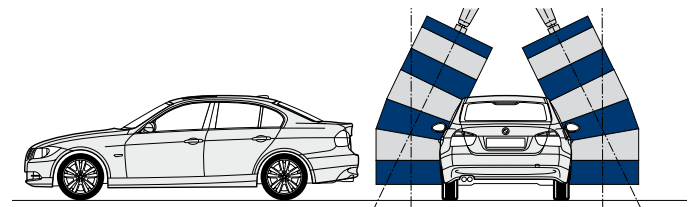

- Roof rails
- Side
- Sill area



High performance, gentle and even pressure, low immersion depth

Available for:

| VARIUS | GENIUS PRIMUS | QUANTUS | VARIUS 1+1 | VARIUS TAKT

WHEEL MASTER

The intelligent wheel washing system

ACCOMMODATING EVEN THE
BIGGEST WHEELS ON THE MARKET



Our answer to the increasingly diverse range of wheel and rim sizes goes by the name of WHEEL MASTER: The intelligent wheel washing system detects the wheel position and diameter by way of a sensor system and selects the appropriate wheel washing program automatically.

While smaller wheels are washed according to the standard washing procedure, the wheel washer tackles large wheels by way of four-dimensional movement.

As such, WHEEL MASTER is particularly suitable for innovative car wash operators whose markets are made up of vehicles with a wide range of wheel sizes thus creating the desire to maximise the target group. WHEEL MASTER is a development of our tried and tested standard wheel washing system thus ensuring high reliability and longevity. It is possible to combine the WHEEL MASTER with a high-pressure wheel washer.



Your benefit:

- Optimum wheel washing result for all wheel sizes
- 4D technology with 3 working axis & mobility
- Continuation of tried and tested wheel wash system
- Angled wheel wash disc for an optimised high-pressure sill washing process

Available for:

| VARIUS | GENIUS | PRIMUS | QUANTUS | VARIUS 1+1 | VARIUS TAKT

Wheel wash systems

For a brilliant washing result

Brush wash



Our wheel brush with integrated high pressure system sets a new standard for wheel wash systems. Several different types with different numbers of nozzles and water volumes are available. With the automatic direction change even hard to reach areas are cleaned properly.

Available for:

| VARIUS | GENIUS | PRIMUS | QUANTUS | VARIUS 1+1 | VARIUS TAKT

Rotating high-pressure

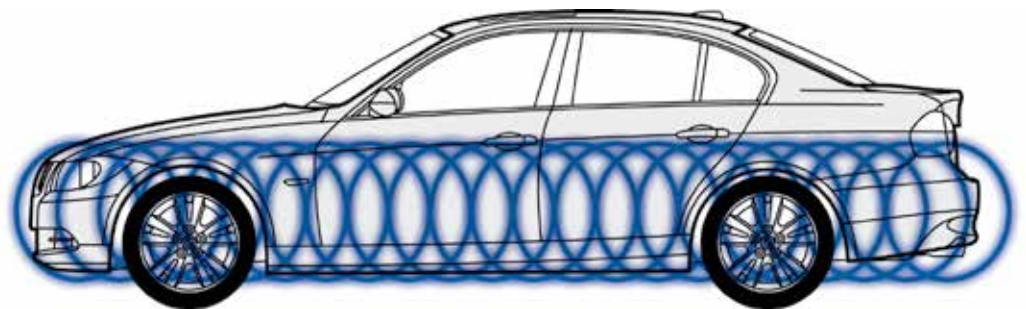

The additional high-pressure equipment for the wheel-wash brush ensures that the wheel and sill areas undergo an efficient pre-wash cycle. A number of different performance levels are available for selection. On the models in the Classic segment and upwards, the brush discs are angled during high-pressure washing cycles to improve coverage of the sides of the vehicle.

Available for:

| VARIUS | GENIUS | PRIMUS | QUANTUS | VARIUS 1+1 | VARIUS TAKT

Direct drive for brushes

Roof and side cylinders



Only Christ offers the direct drive for roof and side brushes. This revolutionary system does not need a gearbox and reduces the electrical consumption of the motors by approx. 10%. The frequency of the rotations are controlled electronically and can be adjusted via software. In this way, Christ washing systems with direct drive are today already ready for future wash materials. Other advantages are the fast and wear free direction change of the brush rotation and the 300 RPM slingshot program that frees the brush of any water drops before the drying process starts.



Advantages:

- Low energy consumption and higher energy efficiency
- Variable brush rotation frequency
- Front + side wash 100 RPM
- Slingshot program roof brush 300 RPM
- Slow anti drip program of the roof brush with 10 RPM
- Increased wash performance
- Very smooth and silent wash
- No dripping from roof brush
- Very fast direction change of the brush rotation
- The system can be converted to various washing materials without hardware conversion. (For example SENSOFI+L to SENSOTEX+).

Available for:

| VARIUS | GENIUS | PRIMUS | QUANTUS | VARIUS 1+1 | VARIUS TAKT

MAXI FLEX+

Inclined side cylinders for an optimised rear wash

Roll-Over Systems with MAXI FLEX+ set new standards for rear wash cycles. The MAXI FLEX+ system allows the two side cylinders to be inclined by up to 25°, the largest inclination available on the market. The only way to ensure that the rear of the vehicle, rear spoilers and vehicles with a dynamic design and inclined rear windows are washed comprehensively is by employing this significantly larger brushing angle.

The side cylinders positioned at the front of the GENIUS and PRIMUS models ensure that the rear of the vehicle is washed beyond the centre point, even if they are inclined backwards. This means that even difficult areas such as number plate indentations and recesses in the bumper can be reached in an optimum fashion, ensuring a much-improved washing result.

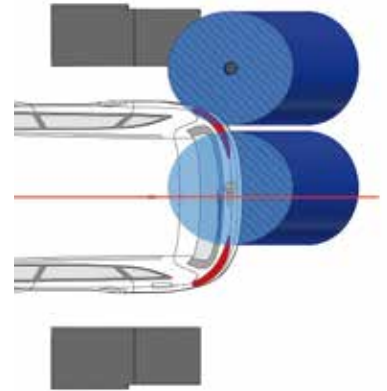

Comprehensive centre cross-over wash with inclined brushes

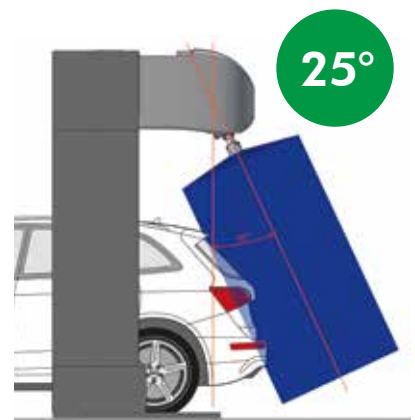

Inclination angle of up to 25° to get into every contour

MAXI FLEX+ can also be combined with the jointed brush. As a result, the inclination in the rear area flawlessly joins the lateral wash with jointed brushes covering the whole of the vehicle's sides. If the vehicle has a hatchback-style rear end (e.g. vans), the side cylinders remain locked in the vertical position. Available for a maximum clearance height of 2,400 mm.

Your benefit:

- Suitable for all vehicle shapes
- Maximum side cylinder inclination of 25°
- Comprehensive centre cross-over wash eliminating all wash shadows
- Optimum washing result in the rear area

Available for:

| VARIUS | GENIUS | PRIMUS | QUANTUS | VARIUS 1+1 | VARIUS TAKT

Brush materials

For each application the right material

Besides the standard PE brushes there are different choices of brush material. The following list will give you a comprehensive overview over the advantages of the different types of brush materials. Please note that a foam and high pressure pre-wash is strongly recommended for an optimal result.

Our highlights in detail

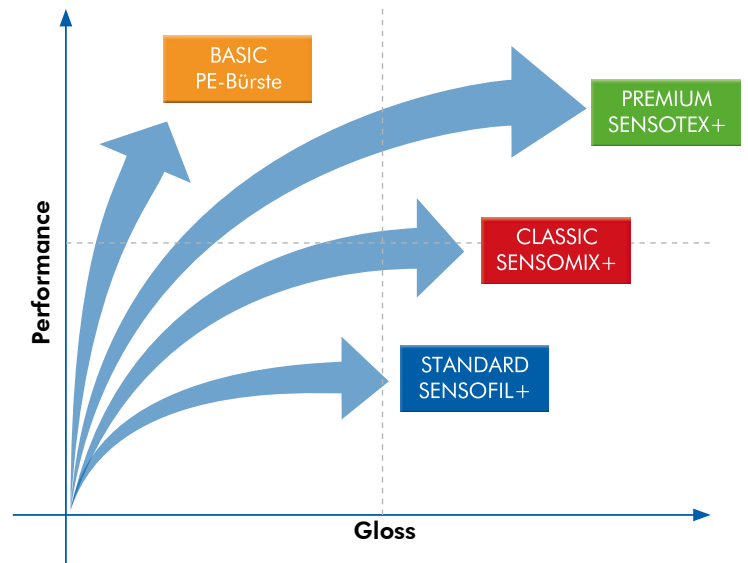

SENSOFIL+

Advantages:

- High durability
- Good performance
- Low brush abrasion on the car's surface
- Average gloss effect

Available for:

| VARIUS | GENIUS | PRIMUS | QUANTUS | VARIUS 1+1 | VARIUS TAKT



SENSOMIX+

Advantages:

- High durability
- Very high performance
- Very low brush abrasion on the car's surface
- High gloss effect

Available for:

| VARIUS | GENIUS | PRIMUS | QUANTUS | VARIUS 1+1 | VARIUS TAKT

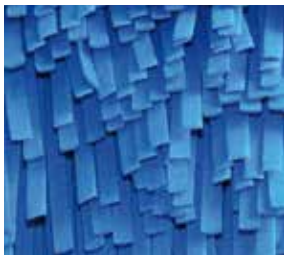

SENSOTEX+

Advantages:

- High durability
- High performance
- No brush abrasion on the car's surface
- Highest gloss effect
- Can be advertised as „textile wash“

Available for:

| VARIUS | GENIUS | PRIMUS | QUANTUS | VARIUS 1+1 | VARIUS TAKT

MAXIMUM POWER FOR A
PERFECT DRYING PROCESS



TURBO DRY

The intelligent vehicle drying system

The TURBO DRY optional equipment offers a premium vehicle drying process that increases the maximum output of the roof blower to 2 x 4.0 kW. TURBO DRY is an intelligent drying process that controls the performance level in relation to the vehicle surface.

The maximum blower output is used on complex areas of the vehicle such as the front and rear area. The blower output is reduced to the minimum level required for surfaces that are easy to dry. This ensures that a perfect balance between energy conservation and drying performance is struck.

We recommend combining this equipment with a VISUS display system or RGB lighting effects in order to draw your customers' attention to this option as a wash experience.



Power level:
| TURBO | OPTI | ECO

Your benefit:

- Premium drying for all vehicle shapes
- Efficient use of power by way of three performance levels
- No extended program runtimes
- Can be combined with RGB display systems

Available for:

| VARIUS | GENIUS | PRIMUS | QUANTUS | VARIUS 1+1 | VARIUS TAKT

Under-chassis wash units

Robust under-chassis wash units for comprehensive vehicle care

The vehicle washing process is not complete until the underbody has been washed. As the vehicle underbody is particularly susceptible to dirt residue and grit, which may cause rust, washing the underbody on a regular basis maintains the value of the vehicle and, as a result, is a popular service amongst many car wash customers.

Fixed pipe under-chassis wash unit

This robust standard system for washing the underbody is cost-effective and reliable. The two fixed jet systems have 18 spray nozzles that are arranged at an angle of 60° to each other. This ensures comprehensive coverage of the vehicle underbody and a high level of cleaning performance. Supply via a 5.5 kW pump at 16 bar and 100 l/min.

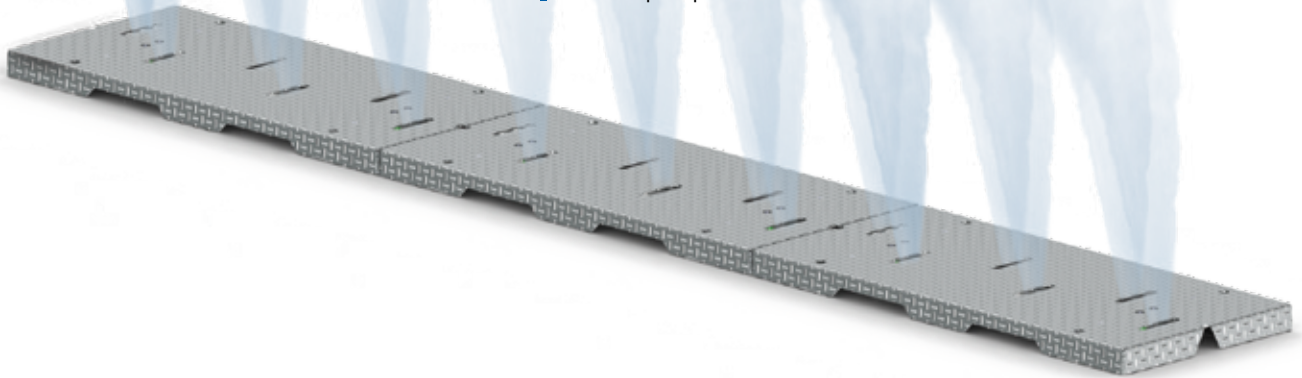

Swivelling under-chassis wash unit

This under-chassis wash unit has two pneumatically driven swivelling jet pipes. This ensures greater coverage of the vehicle underbody and an improved level of cleaning performance. Supply via a 5.5 kW pump at 16 bar and 100 l/min.

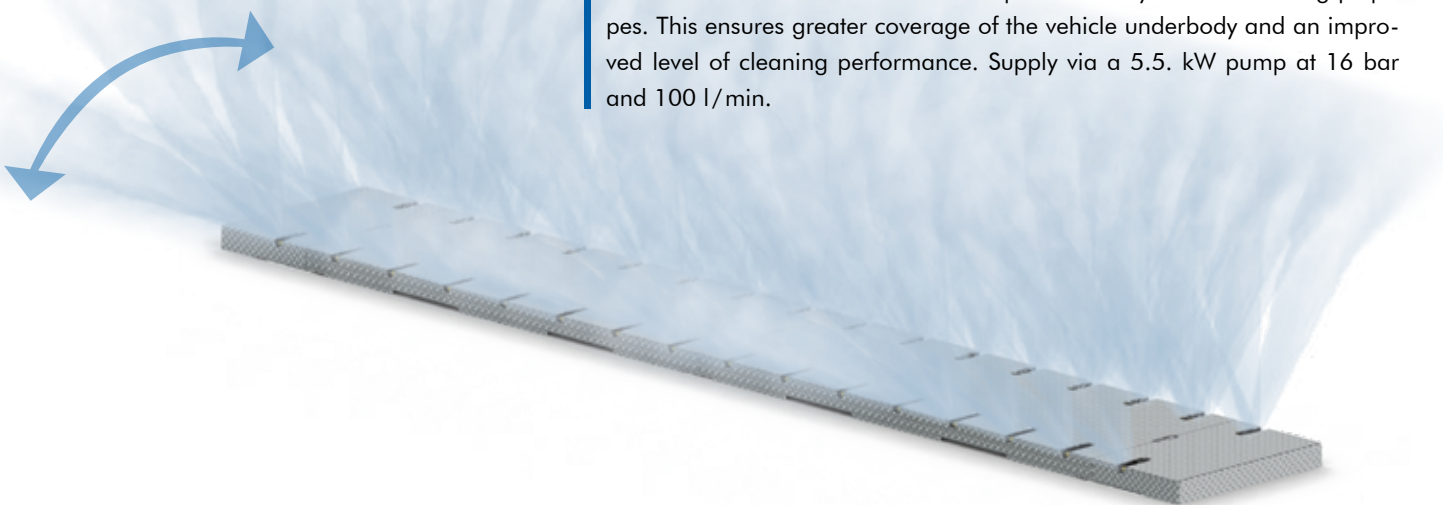

Available for:

| VARIUS | GENIUS | PRIMUS | QUANTUS | VARIUS 1+1 | VARIUS TAKT

Rotating under-chassis wash unit

Effective and economical with precise vehicle length detection



Christ's patented rotating under-chassis wash unit combines the highest level of cleaning performance and efficient, resource-friendly operation thanks to intelligent technology.

Cleaning takes place efficiently via two rotating high-pressure jets which are mounted on a mobile carriage. The rotation of the water jets makes it possible to clean the vehicle underbody in full with a water consumption of only 20 l/min at a pressure of 85 bar.

The rotating under-chassis wash unit has a vehicle length detection system that ends the spraying process at the very end of the vehicle, thus preventing water from being sprayed beyond the rear of the vehicle and the wastage of water, as is unavoidable in conventional systems.

The water consumption and operating pressure have been designed in such a way that the rotating under-chassis wash unit can be supplied by a 4.0kW high-pressure pump of the roll-over wash system. Doing without a separate pump lowers the investment and operating costs and frees up valuable space in the technical cabinet.

Christ's patented rotating under-chassis wash unit combines the highest level of cleaning performance and efficient, resource-friendly operation thanks to intelligent technology.

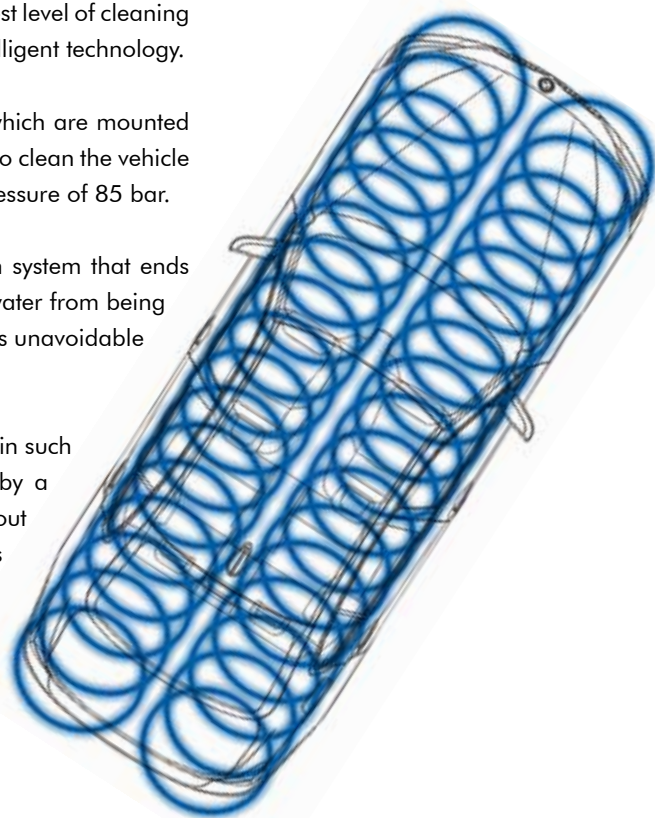

Available for:

| VARIUS | GENIUS | PRIMUS | QUANTUS | VARIUS 1+1 | VARIUS TAKT

User terminal VARIO

The functional operating unit in a modular system

The VARIO is the central control unit of the Christ roll-over wash unit system. The customer chooses the washing programme he wants and then is in charge of the operation himself. For the operator, the VARIO is the central access point, through which all the configurations and operating data is accessed.



VARIO-XS

Every Christ Roll-over wash unit comes free of charge with the self-service enabling device VARIO-XS for wall-mounting. The self-service operation is being activated by entering a wash code manually (possible with a C-ST bought ticket). The VARIO-XS has an LED display with membrane keypad, emergency stop and start button in a compact, special plastic casing.

VARIO-L

The „big brother“ of the VARIO-XS has a larger panel for even more convenient operation of the washing plant and a robust aluminium casing. The VARIO-L is characterized by a variety of additional equipment, among others, payment systems and security features.

VARIO TOUCH-S

The VARIO TOUCH-S provides the wash customers a modern, responsive touchscreen for operating the system. The casing is made of stainless aluminium and is covered by a high-quality adhesive foil. Individual designs are possible. VARIO TOUCH-S is also suitable for the drive-in operation.

Available for:

| VARIUS | GENIUS | PRIMUS | QUANTUS | VARIUS 1+1 | VARIUS TAKT

Accessories VARIO-XS, VARIO-L and VARIO TOUCH-S

All three VARIO models are available with the foot mount option. The basic system can be equipped with different accessories and designed to perfectly match the respective operating conditions and system concept. The respective combinations can be found in the table below.

	VARIO-XS	VARIO-L	VARIO TOUCH-S
Operating concept	Membrane key-board with LED display	Membrane key-board with LED display	Touch screen
Foot mounted (height)	1.574 mm	1.100 mm/ 1.400 mm	1.100mm/ 1.400 mm
Audio Module		•	•
Barcode reader for C-ST-ticket		•	•
Operating Concept batch processing		•	•
Operating Concept Drive-In			•
Transponder card reader		•	•
Key switch system access	•	•	
Key switch switching self-service/ manual operation	•	•	
Token acceptor (4 fixed programmes)	•	•	
Coin acceptor (5 coins, 1 token)	•	•	
Coin extractor		•	
Intercom, emergency stop device in payment area		•	
Individual adhesive coverings			•



Christ Shop Terminal (C-ST)

The modern terminal for check-out/payment area

This handy and easy to use device with a graphical user interface and touch control panel is located next to the cash register at the store. With it, the sale of car washes is carried out according to predetermined programmes and wash programme numbers.

By entering the wash programme number, the integrated printer generates a ticket for the wash customers. The device also includes additional functions whereby the operator can control turnover and sales.



The shop terminal can also be equipped with a transponder card reader. E.g. prepaid cards or multiple wash cards are used. The cards will be upgraded via the shop terminal. Each wash is recorded in the shift report. In the operating unit of the washing system, the card is either cancelled or the balance remaining recorded. This booking process is logged in the shop terminal.

Available for:

| VARIUS | GENIUS | PRIMUS | QUANTUS | VARIUS 1+1 | VARIUS TAKT

Your benefit:

- Basic function with ticket system
- No washing without control
- Optional card system
- Optional interface to the POS system
- Optional fault indicator in the checkout area
- Easy to use

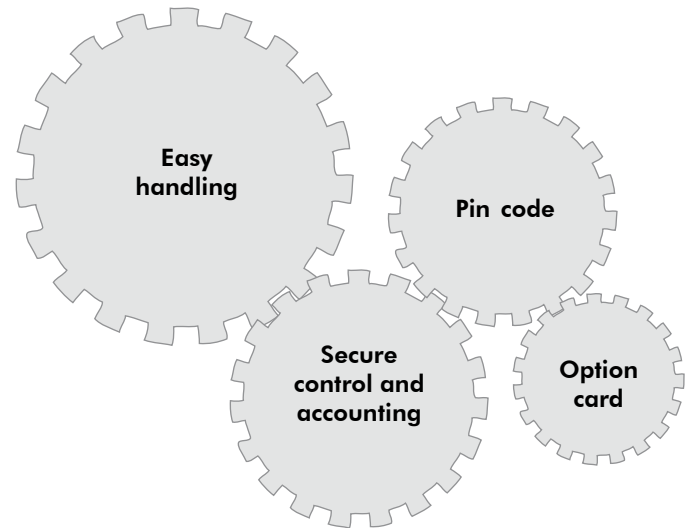

The Premium version of the C-ST is being connected to the wash unit by network cable, Wifi or electric cable (Powerline) and thus allows for manifold operational modes. The Standard version does not dispose of this connection and hence allows only for the sale of individual wash codes (tickets) and optionally transponder cards.

C-ST/Device version	STANDARD	PREMIUM
Execution	wireless	data cable
Number of connectable machines on site	max. 6	max. 6
Day/shift counter	•	•
Day/shift print-out	•	•
Shift print-out with serial number	•	•
Time and date on the shift print-out	•	•
Paperless operation	•	•
Adjustment of the ticket validity period	•	•
Possible validity of tickets	1 day to 100 days	1 day to indefinitely
Number of active tickets (unused, stored)	250	Unlimited
Single tickets	•	•
Multiple tickets (1-20 washes)		•
Happy Hour Tickets (differentiated rates)		•
Promotion Tickets (say 3 for 2)		•
Ticket check/ Verification		•
Ticket Cancellation		•
Goodwill Ticket	•	•
Adjustable Header/footer	5 + 5 lines	5 + 5 lines
EAN code of goods	•	•
Bar code for bar code scanner	•	•
Adjustable access code (layer code, etc.)	•	•
Fault indicator		•
POS interface (subject to surcharge option)	Huth, Tokheim, Bungalski, T-Master	Huth, Tokheim, Bungalski, T-Master
Second Terminal (Master/Slave)		•
Pre-conditions provided by customer	1 x 230 V socket	1 x 230 V socket Laying data cables from the checkout to the washing plant

Christ Information System (C-IS)

Access to washing unit – any time and from everywhere

Web-based Christ Information System (C-IS) provides operators with completely new options in daily operation and offers new business opportunities. Washing units and external systems like security cameras for example are connected with the central Christ server via secure internet connection. Operators get worldwide access to process data of the system with any web-enabled device (PC, tablet, smartphone, etc.).

Operators of single wash stations can easily control their system by remote-control, without having to be constantly on site. Operators of large wash parks receive a central access point by C-IS for operation and management of their sites. Important operating data such as chemical levels and functions such as the integrated machine self-test are available in real time. Furthermore C-IS gives the operator at any time a quick overview of sales, distribution of the washing programmes, washing times, etc.

This database can be used easily for example to optimise the revenue potential of the installation with specific analysis and the development of individual marketing activities.

The C-IS remote control module allows, with an appropriate maintenance contract, the Christ customer service or certified dealers to remotely analyse and resolve interferences. Customer service operations on site are limited to a minimum, and



extensive cost savings in the after-sales service are realised. C-IS also allows a remote configuration of the system, including software updates. Machine availability - and thus your revenue potential - rise significantly. These are the reasons why C-IS is used successfully in particular by operators of multiple facilities and sites, operators of self-service car washes without local staff, in units far from service sites and by innovative wash business operators.

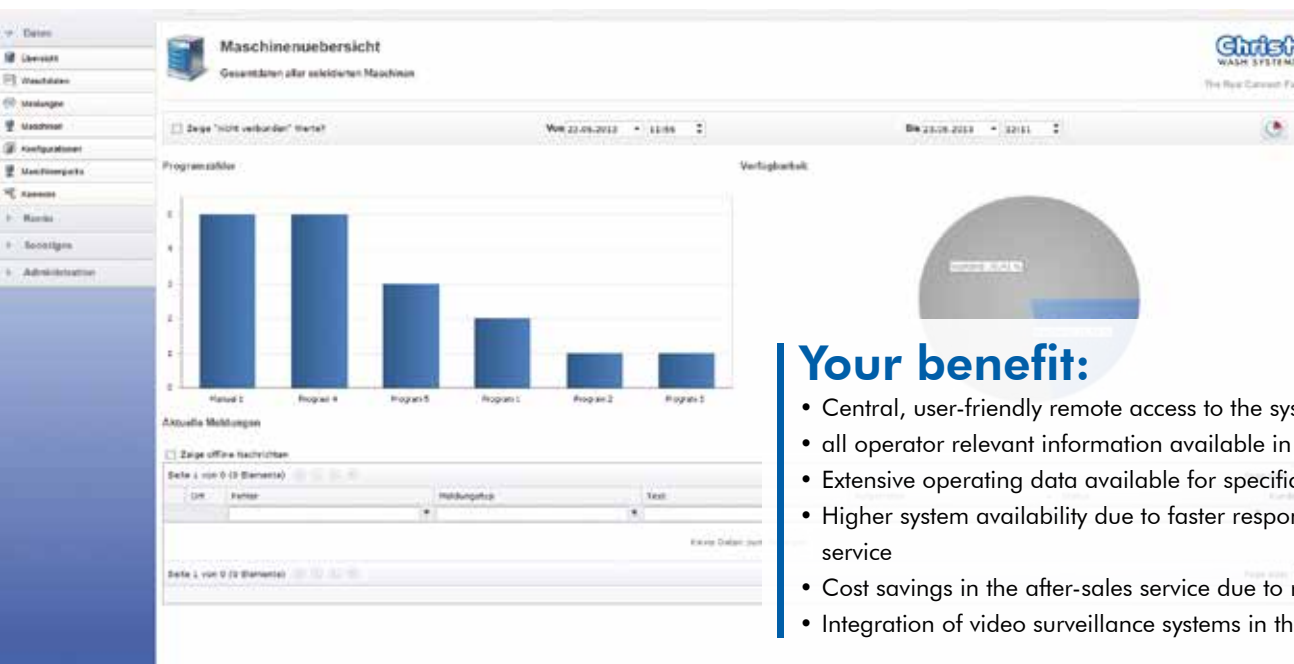

Your benefit:

- Central, user-friendly remote access to the system
- all operator relevant information available in real time
- Extensive operating data available for specific marketing analysis
- Higher system availability due to faster response time of customer service
- Cost savings in the after-sales service due to remote maintenance
- Integration of video surveillance systems in the wash bay

C-IS network

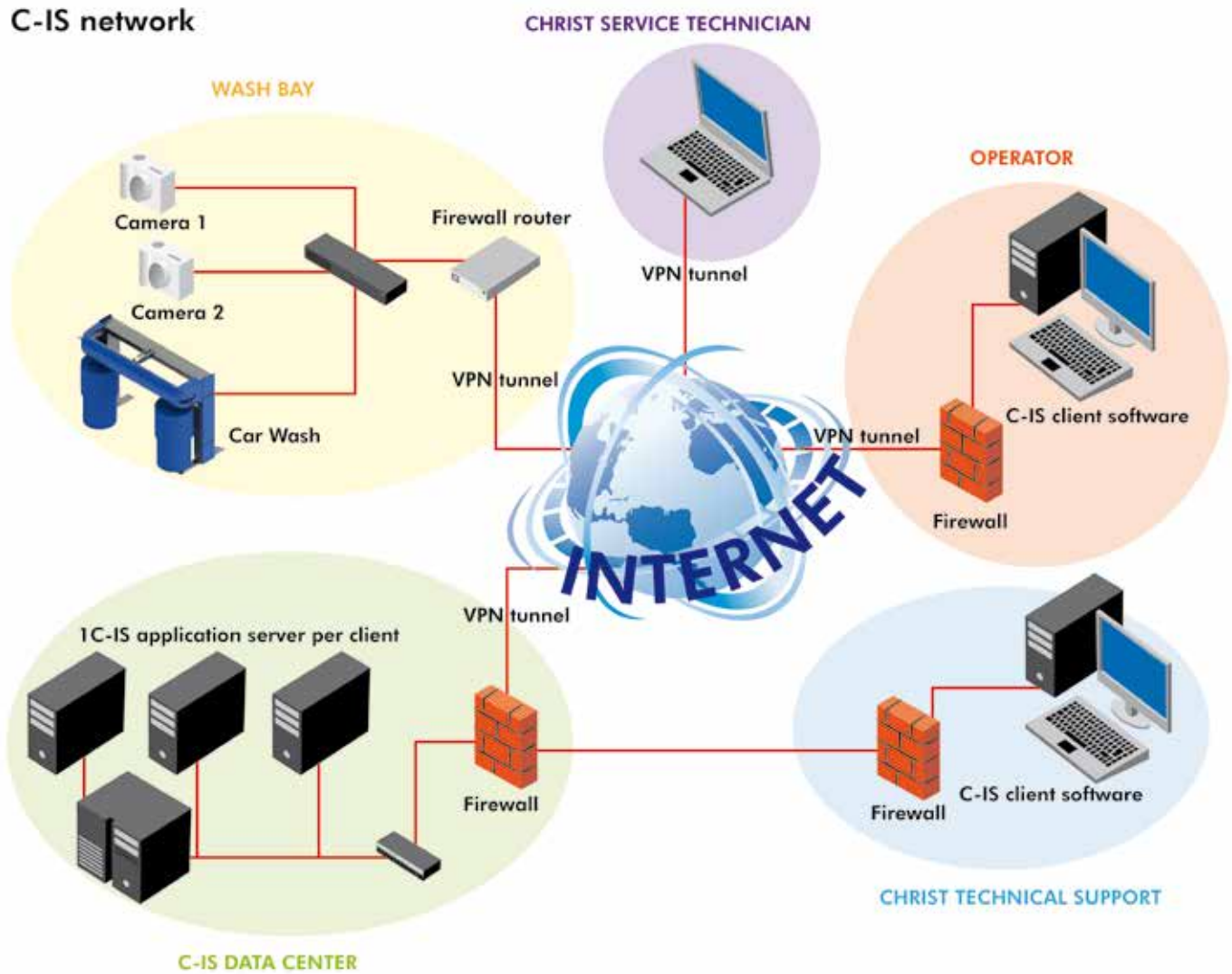

Following functions are available

Support management	<ul style="list-style-type: none"> • real time problem report to operator and Christ help desk • proactive elimination of faults with full maintenance contract • always complete overview of malfunction history via ticket system
Function management	<ul style="list-style-type: none"> • monitoring of system status via Christ help desk • Daily functional system check by integrated self-test • monitoring of chemical levels if available with system type • configuration and software update with online access
Standard version	<ul style="list-style-type: none"> • real-time access to display/analysis of system counter reading • real-time access to display/analysis of malfunction history • analysis of up and down times • access to single machines
Premium version (additional features)	<ul style="list-style-type: none"> • access to individual machines, machine groups or wash parks • export function (pdf, csv, xls)

Available for:

| VARIUS | GENIUS | PRIMUS | QUANTUS | VARIUS 1+1 | VARIUS TAKT

AIR-FIT

Wash bay odourisation

AIR-FIT improves the quality of stay in the washing bay by spraying fragrance concentrate and thus ensures a pleasant fresh scent. The activation takes place either via the system control or manually. Especially in washing bays with process water operation the appeal to customers is significantly cost-effectively increased.

Christ CAR CARE offers a wide range of all-season and seasonal fragrances for AIR-FIT. The system is characterized by low operating costs (1 litre concentrate of fragrance lasts for up to 10,000 washes) and variable applications. Only requirement on-site is a compressed air connection. AIR-FIT is delivered including 1 litre of fragrance concentrate.



Available for:

| VARIUS | GENIUS | PRIMUS | QUANTUS | VARIUS 1+1 | VARIUS TAKT

Technical container for roll-over wash units

As a cost-effective and flexible alternative to an on-site equipment room Christ offers a ready-to-use technical container for roll-over wash units. They include and protect all external system components and extra equipment from central control cabinet to supply pump and osmosis plant.

FONTIS water recycling systems are also available in a technical container. The Christ technical container is the ideal solution for new outdoor systems because only necessary preliminary work is ground work and the laying of supply lines.



Modell	dimensions
Technical container standard for basic components, chemical supply, high/medium pressure system	2.000 x 1.000 x 2.685 mm
Technical container XL for basic components, chemical supply, high/medium pressure system, water softening/reverse osmosis system	3.000 x 1.000 x 2.685 mm
Technical container FONTIS for water treatment plant FONTIS-S	2.000 x 1.000 x 2685 mm

Vacuum cleaner

SOLO-TURBO / DUO-TURBO

TURBO is our compact suction unit for self-service interior cleaning with one or two suction devices. Operators of roll-over wash units can expand their range of services cost-efficiently to self-service interior cleaning. The high-performance and low-wear technology (side channel blowers) is placed in a sturdy case. The white LED strip surrounding the case guarantees an appealing look in twilight hours. The TURBO self-service vacuum cleaner are provided with high-quality fabric hoses and flexible suction nozzles for smooth-running and easy working.



TURBO vacuum cleaner can be activated with coins or tokens - available on request is the connection to a coin extracting system or the activation with pay-keys or transponder cards. Running time of a vacuum run is individually adjustable, the revenue controlled by a coin counter. Optionally available for TURBO-cleaners are vacuum cleaner islands with galvanized crash protection - the perfect alternative to on-site upstands. The vacuum cleaner island also provides space for the Christ carpet beater and waste bin.



Standard included:

LED stripes integrated in lid (color white). Illumination of the outside of the vacuum box for an appealing look in twilight hours.

Central vacuum cleaning system HURRICANE

For large wash centres with a high demand of vacuum places Christ offers the central vacuum system HURRICANE for up to 20 bays. Depending on the business model it can be used by payment or offered as a free deal (included in car wash). HURRICANE is a flexible system that adapts optimally to local conditions. The

suction pipeline is installed either on site at the existing roof suspensions or supports or supported by free-standing Christ beam supports. The HURRICANE vacuum cleaning system is also provided with a technical container.



Water is valuable

The more important thing is to use it carefully. Pure drinking water usually is too valuable to use for just the washing of vehicles. Therefore it is reasonable to recycle the required washing water in a circulation system. In addition to environmental aspects, legal rules and economic factors, such as the cost of drinking and waste water, also play a role in this decision.

FONTIS water recycling systems are specially developed for the use with washing bays. In a compact form they combine the complete technique including washing water storage tank, quartz gravel filter and booster pump. Optional feature: chemical pre-treatment process (Flocculation). FONTIS-S is specially designed for roll-over wash units and is in accordance with the general building inspection approval from Deutsches Institut für Bautechnik (DIBt Berlin) (German Institute of Building Techniques).

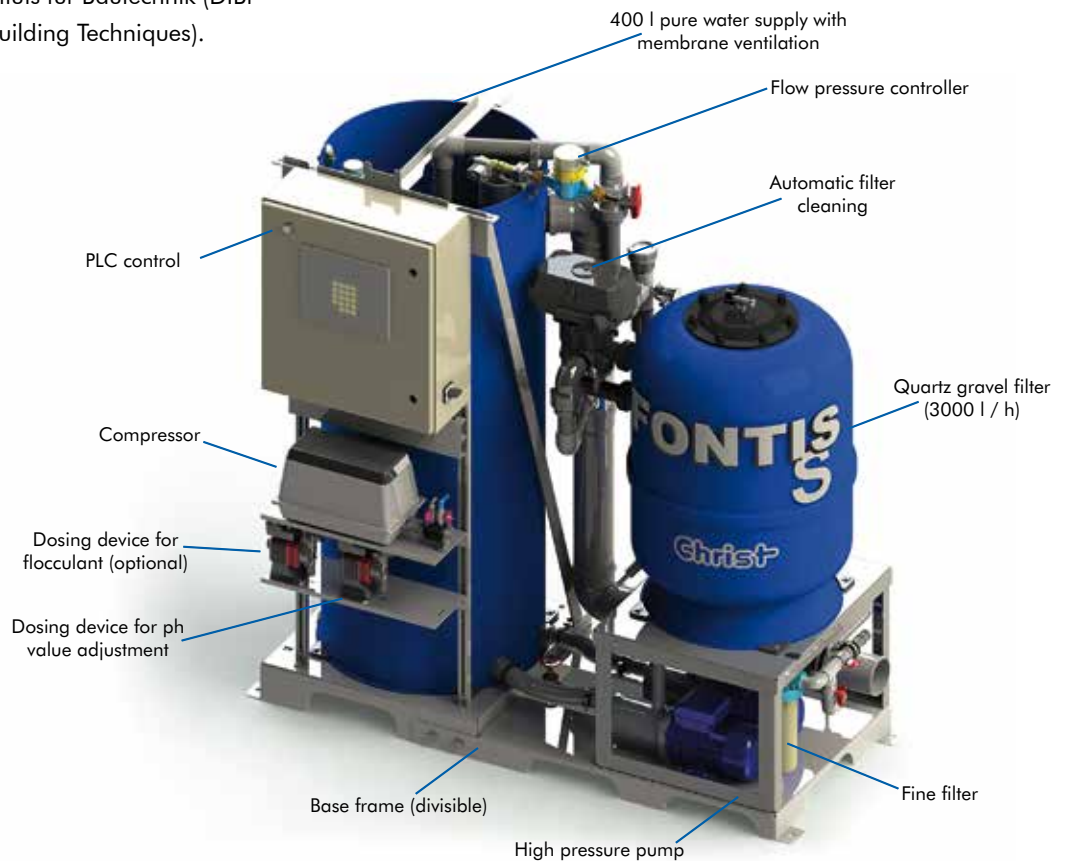
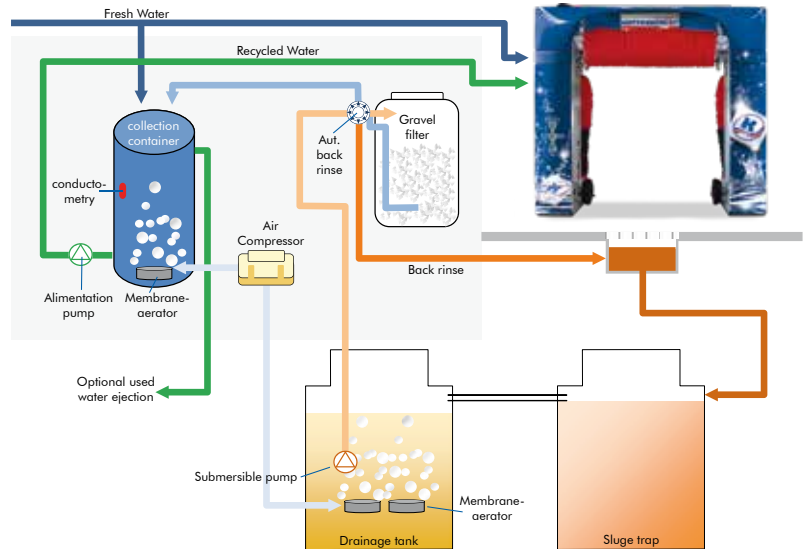

Available for:

| VARIUS | GENIUS | PRIMUS | QUANTUS | VARIUS 1+1 | VARIUS TAKT

BIOCLEAR

BIOCLEAR-S water recycling system for roll-over wash units

Biological top performance

This water recycling system of the next generation has an excellent recycling water quality. Pollutants are effectively degraded in a bioreactor. A continuous circulation and ventilation of process water prevents unpleasant odours. Solids in recycling water are continuously discharged. There is no need for a back flush. So the capacity of the water recycling system is continuously available.

Christ BIOCLEAR also disposes of the general building approval by Deutsches Institut für Bautechnik (DIBt Berlin).

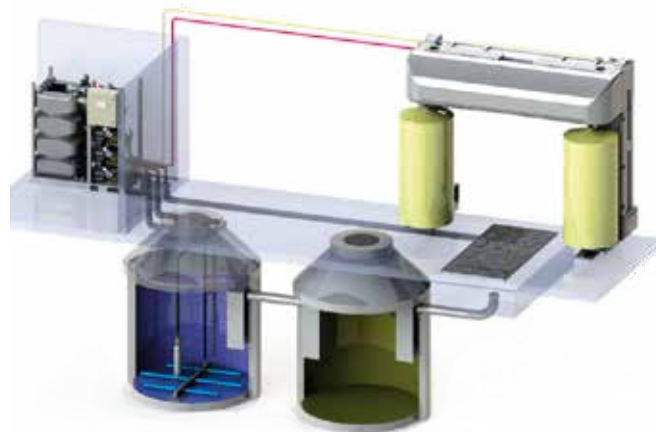

Features

Salt content is measured continuously in order to avoid staining. If necessary, fresh water is added automatically. The bioreactor can also process waste water containing mineral oils. The modern PLC control of the next generation offers a web based system management and monitoring. BIOCLEAR can be integrated in C-IS, so full remote functions are available. Finally, the housing in attractive design enables the installation directly into the wash bay to actively promote the water recycling system technology to the customer.

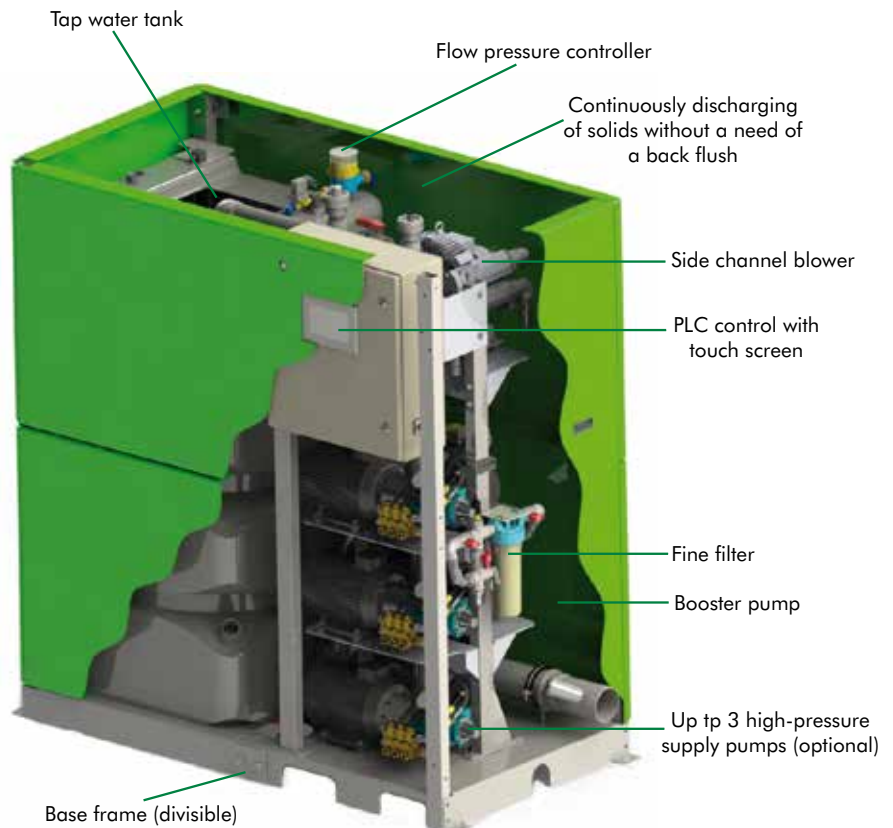

Available for:

| VARIUS | GENIUS | PRIMUS | QUANTUS | VARIUS 1+1 | VARIUS TAKT

Further Christ Products:



Wash tunnels EVOLUTION

The flexible modular construction system for your car wash, whether short-wash or high-performance system. The focus of the EVOLUTION series is on quality, operator-friendliness and optimized washing processes. A wide range of alternative technologies and components opens up numerous combination options and offers the optimum solution for everyone's needs.



Wash Bay System SKYLINE

The modular wash bay SKYLINE is the right choice for every site. Two roof variants and a variety of customizable exterior finishes offer the operator the ability to individualize. When designing the SKYLINE system, value was placed on operational, cost-effective and energy-efficient technology. The equipment can be designed freely so that revenue-generating programmes may be involved.



Wash Bay System SKYWING

SKYWING is the focal point in the wash bay area. The bright, attractive roof design attracts customers from afar and offers car washes in a feel-good atmosphere. The SKYWING is also available in the same flexible, design options for construction and equipment as the washing bays of SKYLINE.

Christ
CAR CARE



Christ CAR CARE

www.christ-carwash-shop.com

Christ CAR CARE offers a complete range of detergents and maintenance care products. Our wash chemicals are optimally matched to our car washes – used in combination they guarantee the best possible result! In addition, Christ CAR CARE offers highly attractive market innovations such as PROTECT SHINE, which boost the value of your investment significantly. Christ CAR CARE uses only biodegradable surfactants and ecologically harmful substances such as complexing agents are not used.

Commercial vehicle washing systems for buses

We offer the right wash plant for each bus operator: Transit systems with washing times of 2.5 minutes which are perfect for high throughput for large fleets. Roll-over systems with their special lateral brush suspension are ideal for coaches, buses and low-floor buses. The automatic circumnavigation of outside mirrors ensures high operational safety. Christ also offers solutions for the washing of trolley coaches.



Commercial vehicle washing systems for trucks

Christ also offers highly specialized washing facilities for trucks. Technical solutions such as automatic mirror circumnavigation or Jetstream all around high-pressure washing with oscillating jets are only offered by Christ Washing Systems. Special solutions for forwarders, contract washing and public transport companies provide the best washing results with low operating costs.



TRAM and TRAIN WASH Units

The train and tram wash systems can be designed in various concepts, such as stationary wash, semi-stationary wash or for drive-over wash of trains and trams, with or without pantographs. Our various frame structures may be equipped with swivelling, split horizontal or continuous wash rolls to optimally clean the front and rear surfaces.



Xpress

www.christ-carwash-shop.com

Christ Xpress is the focal point for the entire car accessory requisites. Either by catalogue or online shop operators, Xpress provides everything that is needed for the car wash business – from additional devices, work clothing and wash chemicals to an extensive range of advertising material.



The Real Car Wash Factory

Christ
WASH SYSTEMS

Everything from a single source

...from Christ Wash Systems

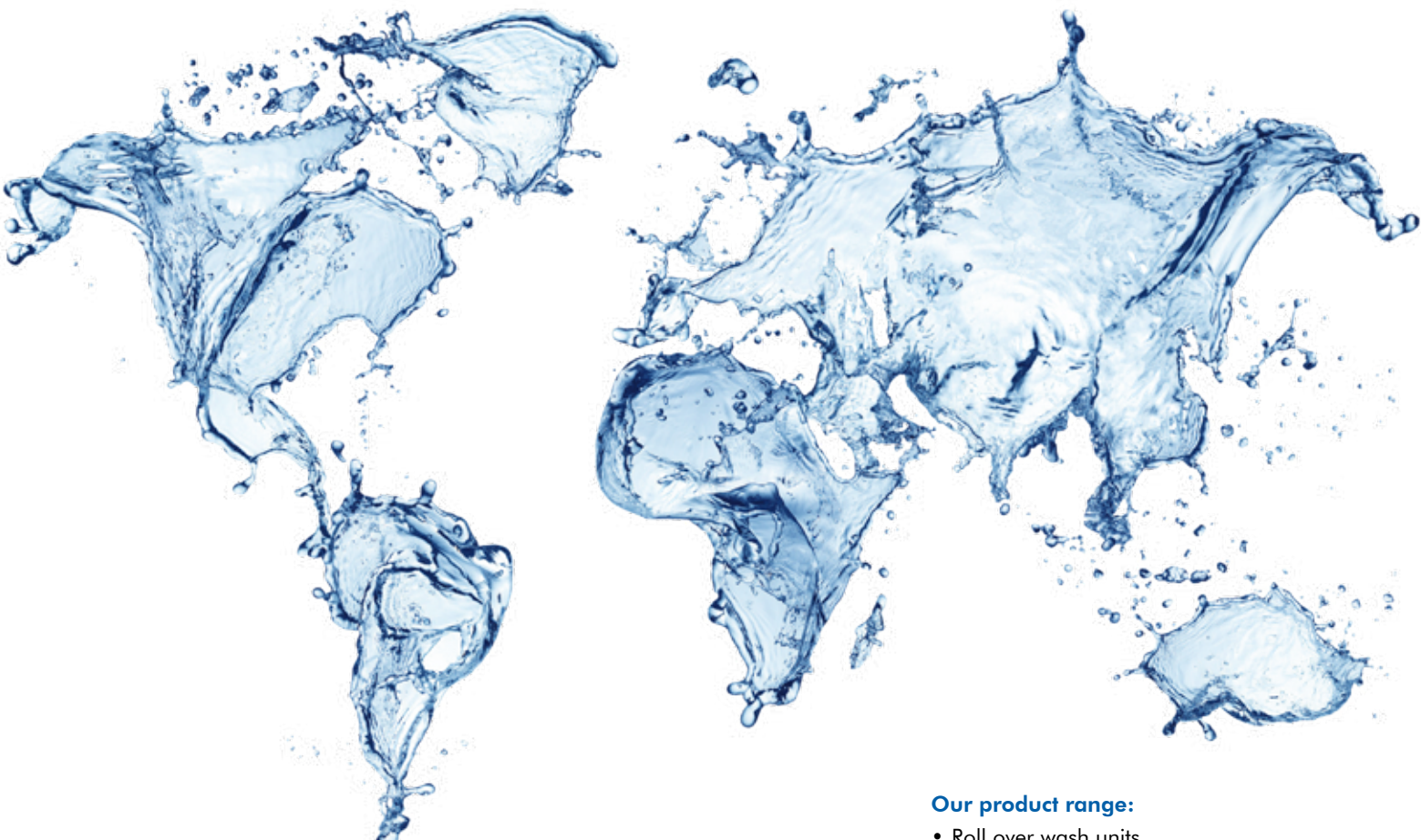

Our nation-wide customer service guarantees fast help.

- Nation-wide on-site service
- Service central with hotline
- Quick supply with expendable and spare parts already in the service vehicle

Our services:

- Location analysis
- Profitability calculations
- Project planning
- Operator workshops
- Financing concepts
- Marketing help

Our product range:

- Roll over wash units
- Wash tunnels
- Water preparation units
- Self-service wash systems
- Commercial vehicle wash units
- Self-service vacuum cleaners
- Advertising material and accessories regarding car wash
- Car wash and care products
- Customer retention system and video surveillance

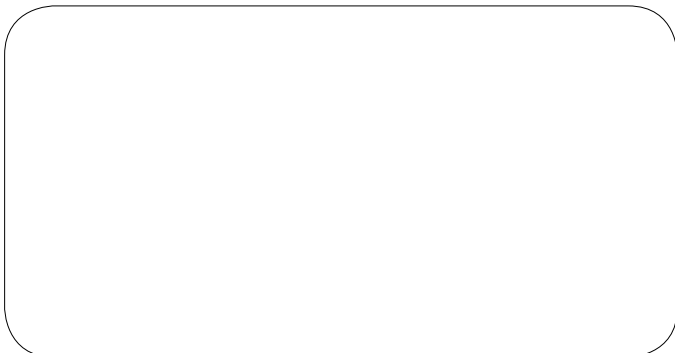

Otto Christ AG • Wash Systems • PO Box 12 54 • 87682 Memmingen • Germany
Phone: +49 8331 857-200 • E-mail: sales@christ-ag.com • www.christ-ag.com

